



4051E01

ROM EXPANDER

INSTRUCTION MANUAL

Tektronix, Inc.
P.O. Box 500
Beaverton, Oregon 97077

MANUAL PART NO.
070-2215-00

First Printing DEC 1976
This Printing AUG 1979

WARRANTY

Tektronix warrants to the original purchaser that this product and options, excluding customer supplied equipment, is free from defects in materials and workmanship, under normal use, for a period of one (1) year from the date of shipment. Tektronix will, at its option, repair or replace the product if Tektronix determines it is defective within the warranty period, and it is returned, freight prepaid, to a Tektronix Service Center.

In the forty-eight (48) contiguous United States and the District of Columbia, and in other areas where Tektronix normally has service available for this product, Tektronix will provide on-site warranty service at no charge during the first ninety (90) days from the date of shipment.

Tektronix shall be under no obligation to furnish warranty service if:

- a. Attempts to repair or service the product are made by personnel other than Tektronix service representatives.
- b. Modifications are made to the hardware or software by personnel other than Tektronix representatives.
- c. Damage results from connecting the product to incompatible equipment.

There is no implied warranty of fitness for a particular purpose. Tektronix is not liable for consequential damages.

Copyright © 1979 by Tektronix, Inc., Beaverton, Oregon. Printed in the United States of America. All rights reserved. Contents of this publication may not be reproduced in any form without permission of Tektronix, Inc.

This instrument, in whole or in part, may be protected by one or more U.S. or foreign patents or patent applications. Information provided on request by Tektronix, Inc., P.O. Box 500, Beaverton, Oregon 97077.

TEKTRONIX is a registered trademark of Tektronix, Inc.

CONTENTS

	Page
SECTION 1 INTRODUCTION	1-1
Description	1-1
Characteristics	1-3
Standard Accessories	1-4
SECTION 2 INSTALLATION AND MAINTENANCE	2-1
SECTION 3 OPERATION	3-1
SECTION 4 CIRCUIT DESCRIPTIONS	4-1
Power Supply	4-1
Primary Circuit	4-1
Secondary Circuit	4-1
Buffer Board	4-1
Introduction	4-1
Address Bus Buffer	4-2
Data Bus Buffer	4-2
Control Board	4-2
Introduction	4-2
Slot Selection	4-3
Bus Enable	4-4
SECTION 5 REPLACEABLE ELECTRICAL PARTS	5-1
SECTION 6 DIAGRAMS	6-1
SECTION 7 REPLACEABLE MECHANICAL PARTS	7-1
CHANGE INFORMATION	

ILLUSTRATIONS

Fig. 1-1	4051E01 ROM Expander	ii
Fig. 1-2	4051E01 ROM Expander Interface	1-2
Fig. 2-1	4051E01 ROM Expander Rear Panel	2-1
Fig. 2-2	Removal of Circuit Card	2-2
Fig. 2-3	Circuit Card	2-3
Fig. 2-4	Circuit Card Insertion for 120 Vac	2-4
Fig. 2-5	Insertion of ROM Pack or Interface into 4051E01 ROM Expander	2-5
Fig. 2-6	Removal of ROM Pack or Interface from 4051E01 ROM Expander	2-5
Fig. 3-1	Primary Addresses of 4051E01 ROM Expanders Plugged into 4051 Backpack Slots	3-1

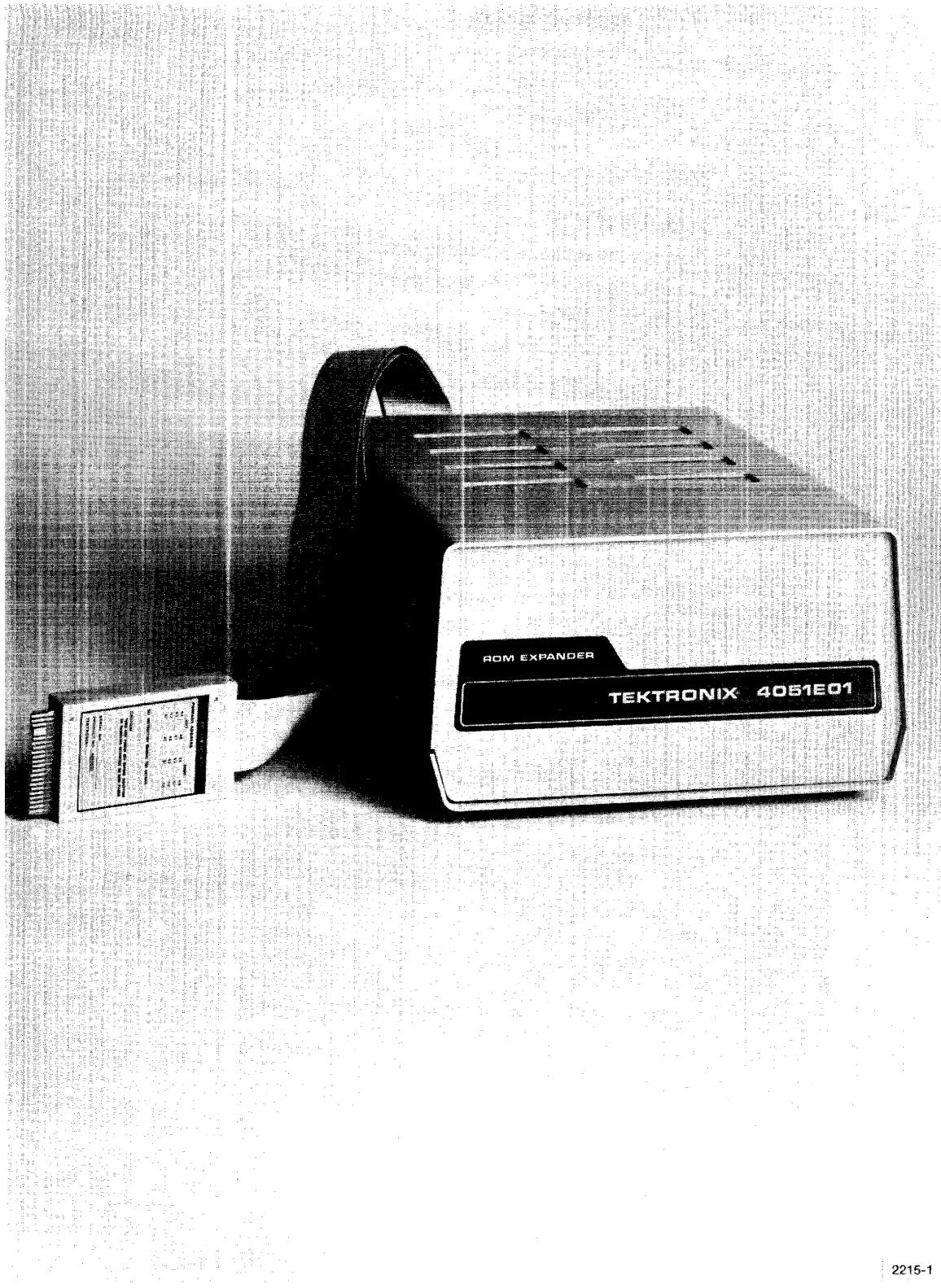

Fig. 1-1. 4051E01 ROM Expander.

Section 1

INTRODUCTION

This manual provides user and service documentation for the 4051E01 ROM Expander, shown in Fig. 1-1. The first three sections provide information for the user, and the remainder of the documentation is for service personnel.

DESCRIPTION

The 4051E01 ROM Expander increases the number of 4051 Graphic System backpack slots into which ROM Packs and interfaces (such as the Option 10 Printer Interface) can be installed. Each ROM Expander provides eight slots for ROM Packs and interfaces and can be plugged into either backpack slot of the 4051.

The 4051 Graphic System can accommodate a maximum of two ROM Expander units, each plugged into a 4051 backpack slot; a ROM Expander may not be plugged into another ROM Expander. Although a ROM Expander has its own power cord, the power supply is controlled through the ON/OFF state of the 4051. After the ROM Expander has been plugged into both the 4051 and a suitable line source, turning ON the 4051 causes the 4051 to memorize the addresses where ROM Packs and interfaces are located.

When the ROM Expander Interface (Fig. 1-2) is plugged into one of the backpack slots of the 4051, all of the microprocessor bus signals required by ROM Packs or interfaces are available to each of the eight slots of the ROM Expander; each slot has its own device address.

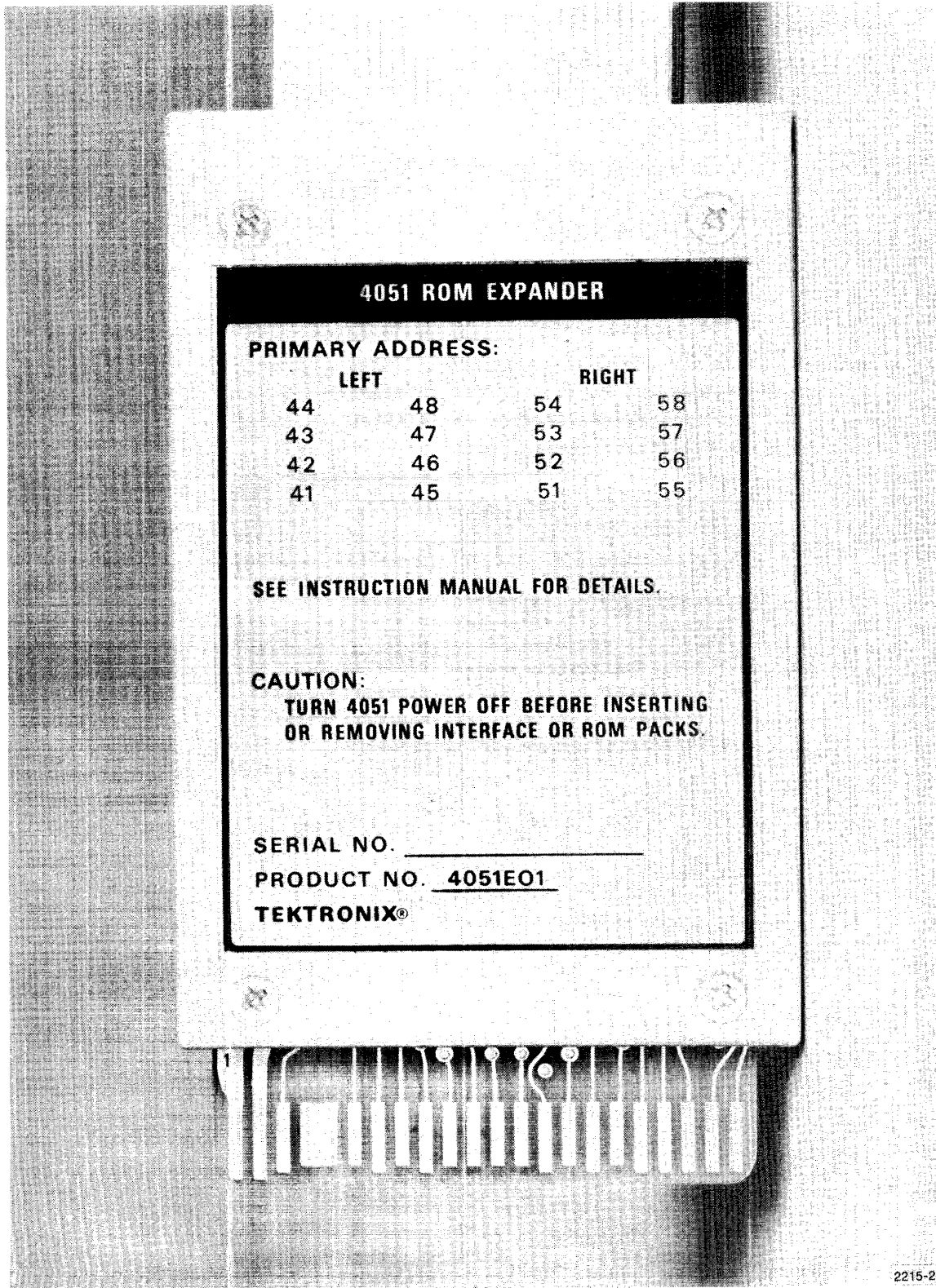

Fig. 1-2. 4051E01 ROM Expander Interface.

CHARACTERISTICS

POWER REQUIREMENTS

The 4051E01 ROM Expander draws power through its own power cord, but its power supply is controlled by the ON/OFF state of the 4051 Graphic System with which it is interfacing. The following power requirements must be met for the operation of the ROM Expander.

Line Voltage Range

Universal Transformer	100, 120, 220, 240 Vac, all $\pm 10\%$
-----------------------	--

Line Frequency Range

Universal Transformer	50 Hz to 400 Hz
Fan	50 Hz to 60 Hz

Power Consumption

90 W maximum

Current Limit

+ 5 Vdc	1.5 A (each)
± 12 Vdc	1 A

Fuse Protection

100, 120 Vac	.8 A slow blow
220, 240 Vac	.4 A slow blow

PHYSICAL CHARACTERISTICS

Length	14.6" (37.0 cm)
Width	10.4" (26.5 cm)
Depth	6.1" (15.5 cm)
Weight	16.0 pounds (7.3 kg)

ENVIRONMENTAL CHARACTERISTICS

Temperature

Operating	+10°C to +40°C
Non-operating	-40°C to +65°C

Altitude

Operating	15,000 feet (4572 meters) maximum
Non-operating	50,000 feet (15,240 meters) maximum

Introduction

Humidity

Operating	0 to 80% non-condensing
Non-operating	0 to 95% non-condensing

Shock

Non-operating	1/2 sine, 11 ms duration, 30 g's
---------------	----------------------------------

Vibration

Non-operating	0.015" DA-10-50-10 Hz
---------------	-----------------------

STANDARD ACCESSORIES

Instruction Manual	070-2215-00
Power Cord	161-0066-00

Section 2

INSTALLATION AND MAINTENANCE

INSTALLATION

Before installing the 4051E01 ROM Expander, see Section 1 (INTRODUCTION) for information on fuse protection and line voltage.

CAUTION

If improper line voltage is selected, the power supply unit may be damaged.

To install the ROM Expander, position the line voltage selector circuit card (an integral part of the power cord/fuse assembly) for the proper line voltage by performing the following steps.

1. On the rear panel of the ROM Expander, remove the power cord, then locate the plastic door covering the fuse holder and slide it upward (Fig. 2-1).

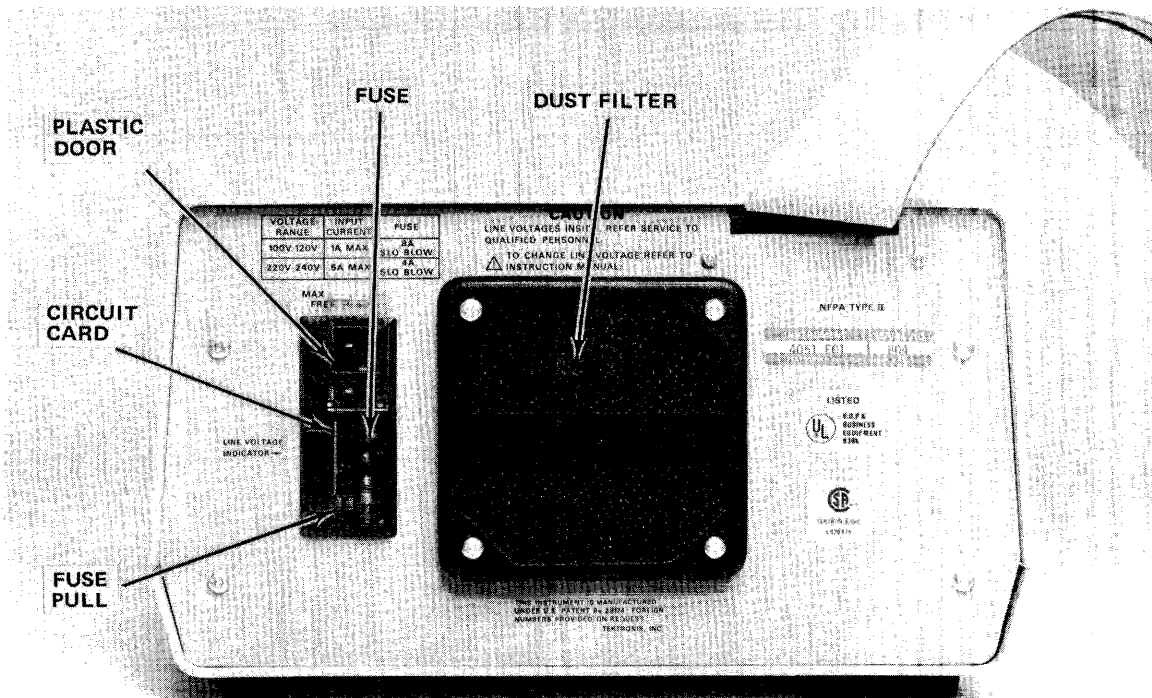

2215-3

Fig. 2-1. 4051E01 ROM Expander Rear Panel.

Installation and Maintenance

2. Slide the FUSE PULL upward as far as possible and remove the fuse.
3. Grasp the circuit card near the center of the nearest edge (at the point where the hole is located) and pull firmly (Fig. 2-2); a pair of serrated needle nose pliers or a similar tool is suggested. Note the vertical position of the circuit card (Fig. 2-3).

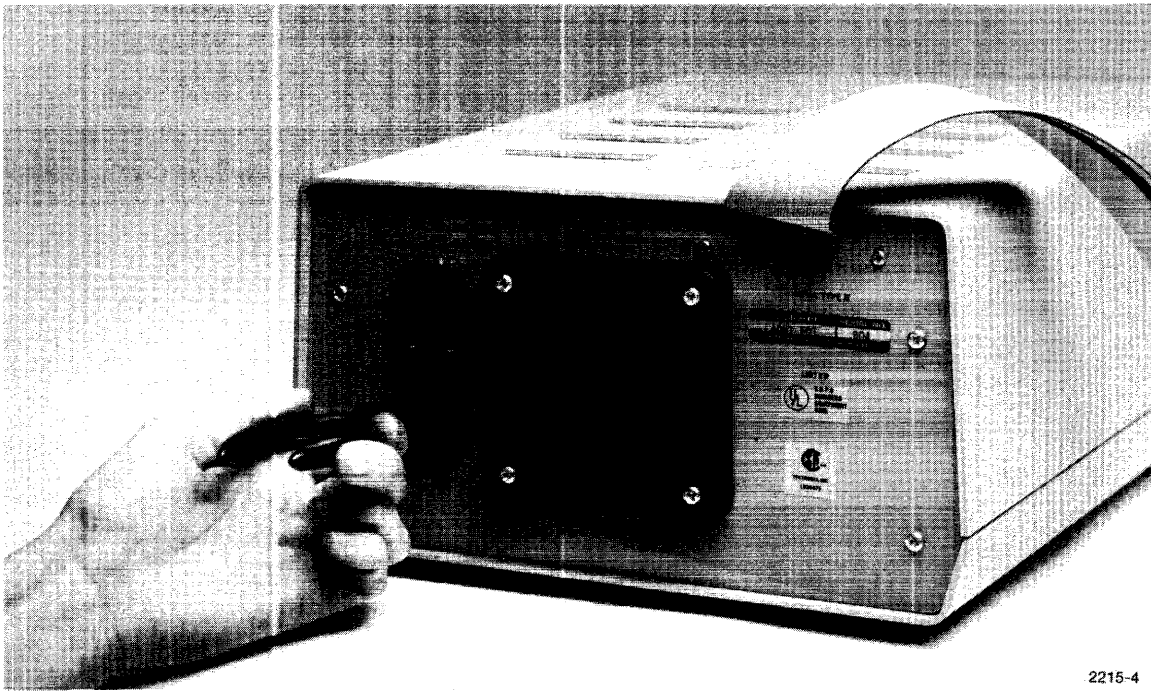

2215-4

Fig. 2-2. Removal of Circuit Card.

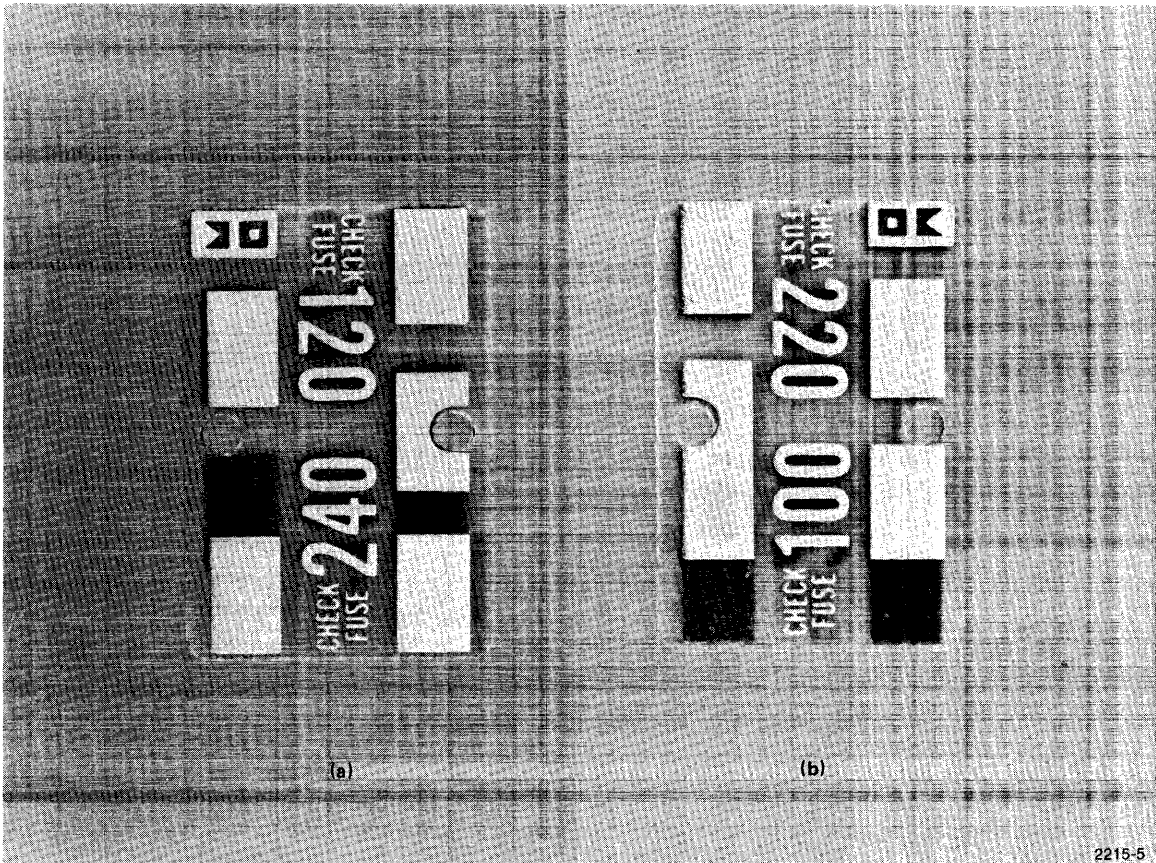

Fig. 2-3. Circuit Card.

NOTE

Proper voltage is designated by the position of the circuit card. One side of the card designates 120 Vac. or 240 Vac. (Fig. 2-3a); the other designates 100 Vac. or 220 Vac. (Fig. 2-3b).

Installation and Maintenance

4. Reinsert the circuit card with the proper voltage designation in the upper position on the right side of the card (Fig. 2-4).

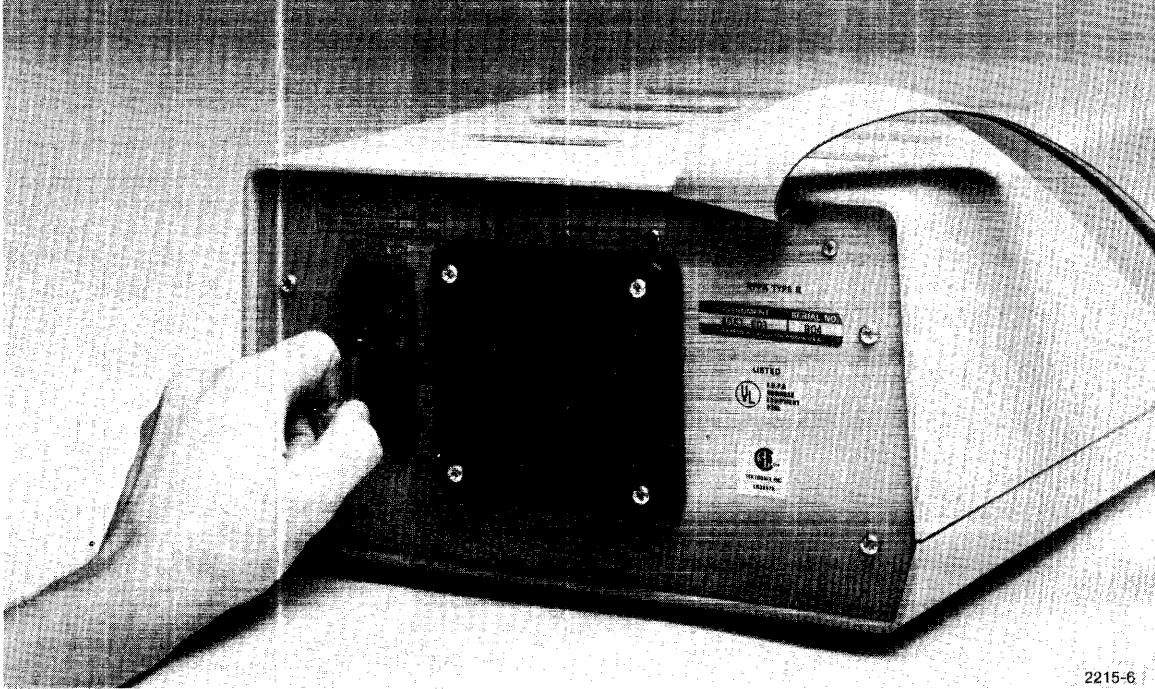

Fig. 2-4. Circuit Card Insertion for 120 Vac.

Slide the FUSE PULL downward. If the circuit card has been inserted properly, the only number on the card now visible is the number corresponding to the correct line voltage.

5. Check fuse size requirements (on the back panel) and change the fuse if necessary.
6. Reinsert the fuse (either end up).
7. Slide the plastic door downward.

Turn OFF the power to the 4051 Graphic System and plug the ROM Expander power cord into the rear panel of the ROM Expander and into a suitable line voltage source.



Inserting any device into or removing any device from a 4051 backpack slot or a ROM Expander slot when the power is ON may cause memory to be erased.

Before turning ON the 4051, insert the ROM Expander Interface (with its instruction label facing front) into one of the 4051 backpack slots by pressing downward until the edgeboard is

firmly seated in the backpack slot. ROM Packs and interfaces are inserted, likewise, into slots of the ROM Expander as shown in Fig. 2-5, and power is controlled by the ON/OFF state of the 4051.

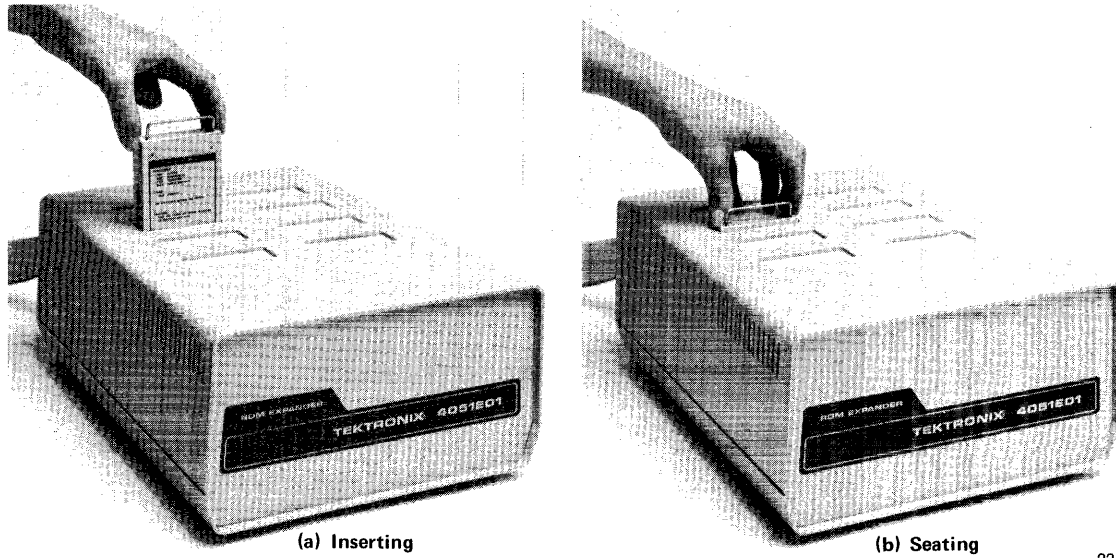

2215-7

Fig. 2-5. Insertion of ROM Pack or Interface Into 4051E01 ROM Expander.

Removal of ROM Packs or interfaces from the ROM Expander is demonstrated in Fig. 2-6.

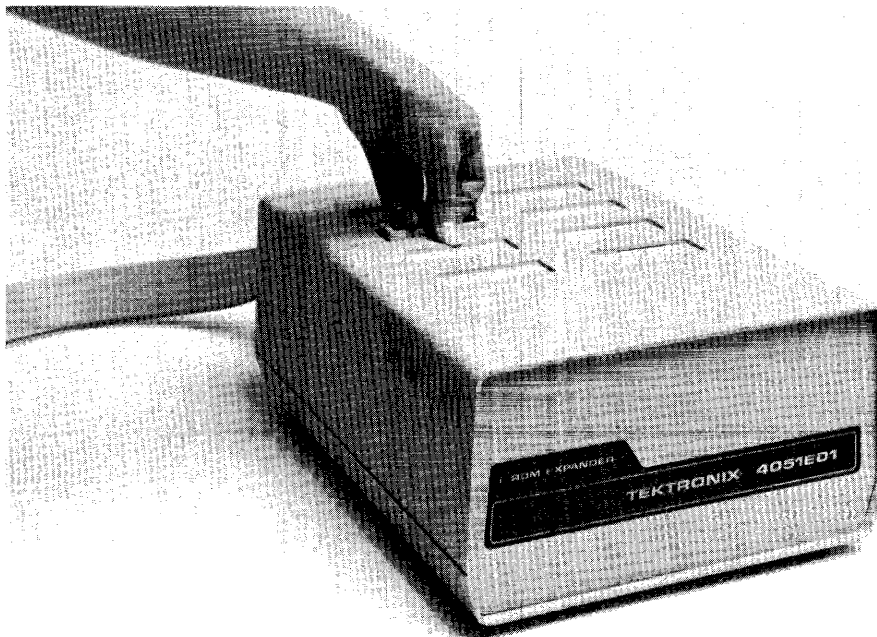

2215-8

Fig. 2-6. Removal of ROM Pack or Interface from 4051E01 ROM Expander.

MAINTENANCE

The rear panel of the 4051E01 ROM Expander unit includes a dust filter (Fig. 2-1) which should be cleaned when necessary by the following procedure.

1. Remove the filter by removing the four Phillips head screws.
2. Clean the filter with soap and water, then rinse and dry thoroughly.



Be sure that the filter is thoroughly dry before it is reinstalled. Do not clean it with a spray or with a solution other than soap and water.

3. Reinstall the filter by replacing the four screws.

Section 3

OPERATION

The 4051E01 ROM Expander is designed with eight slots, each of which may house a ROM Pack or an interface other than another ROM Expander Interface. The ROM Expander Power Supply provides +5 volts, +12 volts, and -12 volts to each ROM Pack or interface, and supplies power to a cooling fan.

Inserting the ROM Expander Interface into the 4051 Graphic System, as detailed in Section 2 (INSTALLATION AND MAINTENANCE), extends the availability of the microprocessor bus to the ROM Expander. When a ROM Pack or interface in the ROM Expander is addressed, address, control, and data lines are buffered and sent to the ROM Expander.

The slots of the ROM Expander are addressed from the 4051 Graphic System through a bank switch. The bank switch functions internally to enable each ROM Pack and interface to respond independently as reference is made to them. When the 4051 is turned on, it interrogates every bank switch combination and commits to memory all addresses where ROM Packs or interfaces are located. The left and right backpack slots of the 4051 have been assigned primary addresses 41 and 51, respectively. A ROM Expander plugged into the left backpack slot of the 4051 is assigned addresses 41—48, as shown in Fig. 3-1; a ROM Expander plugged into the right backpack slot of the 4051 is similarly assigned addresses 51—58 (Fig. 3-1).



2215-9

Fig. 3-1. Primary Addresses of 4051E01 ROM Expanders Plugged into 4051 Backpack Slots.

Operation

When a command, such as the Matrix ROM Pack command **B=TRN (A)**, addresses a ROM Pack in the ROM Expander, the 4051 logically connects the appropriate ROM Expander slot to enable the ROM Pack referenced by the command. When an interface is plugged into a slot of the ROM Expander, the appropriate command logically connects the appropriate slot to enable the interface; the example below illustrates this.

1. The ROM Expander is plugged into the left backpack slot of the 4051, and the Option 10 Printer Interface is plugged into the left rear slot (device address 44) of the ROM Expander.
2. **TLIST @ 44:** is entered via the 4051 keyboard.
3. A copy of the tape file directory for the magnetic tape cartridge currently in the 4051 is sent to the printer in ASCII format.

Section 4

CIRCUIT DESCRIPTIONS

POWER SUPPLY

Refer to the Power Supply Schematic Diagram (1-1).

PRIMARY CIRCUIT

The 4051E01 ROM Expander Power Supply is a conventional power supply. A line filter, a fuse holder, and a line voltage selection circuit card are contained in the power cord receptacle in the rear panel of the ROM Expander.

Although a ROM Expander has its own power supply, the power supply is controlled through the ON/OFF state of the 4051. A relay in the ROM Expander Power Supply is turned on by power from the 4051 to close the primary circuit of the ROM Expander Power Supply.

The line voltage selection system allows four different voltage ranges to be selected. The voltage ranges are 100, 120, 220, and 240 Vac—all within $\pm 10\%$. The ranges are selected by positioning a removable circuit card. Fuse protection is provided by a .8 A slow blow fuse for 100 and 120 Vac and by a .4 A slow blow fuse for 220 and 240 Vac.

The cooling fan is connected, through a pair of terminals, to the transformer so that 110 Vac is always supplied to the fan regardless of which line voltage is applied to the unit.

SECONDARY CIRCUIT

One winding on the transformer steps the ac voltage down from 110 Vac to 15 Vac and another steps the ac voltage down from 110 Vac to 7 Vac. The 15 Vac power supply is rectified through a full-wave bridge and regulated by two three-terminal regulators to output ± 12 Vdc. The 7 Vac power supply is rectified through a full-wave rectifier and is regulated by two three-terminal regulators to output +5 Vdc; these regulators are each capable of delivering 1.5 A. Two of these are necessary because the unit requires 3 A for the +5 Vdc power supply.

All the regulators are protected with a current limit feature; the ± 12 Vdc power supply is limited to slightly over 1 A, and the two +5 Vdc power supplies are limited to 1.5 A. The regulators are protected against extreme heat by automatic downward adjustment of the current limit if the temperature becomes too high.

BUFFER BOARD

INTRODUCTION

The ROM Pack interface between the 4051 and the ROM Expander unit serves as an electrical buffer for the address bus and the data bus. The ROM Pack receives and amplifies the address

Circuit Description

bus and data bus signals from the 4051 and sends them out to the ROM Expander. The ROM Pack also receives and amplifies data traveling from the ROM Expander to the 4051.

Signals are transmitted between the 4051 and the Buffer board through the edge connector of the ROM Pack and between the Buffer board and the ROM Expander on a pair of ribbon cables. Each signal line is provided with a ground return wire to reduce crosstalk and give higher noise immunity to signals passing through the cable.

The Buffer board has two functional parts, the address bus buffer and the data bus buffer.

ADDRESS BUS BUFFER

Refer to the Address Buffer Schematic Diagram (2-1).

The address bus is buffered by tri-state buffer chips. These chips buffer the EPIAS (External Peripheral Interface Adaptor Select), RESTART, MCP2 (Master Clock Phase 2), and PIAE (Peripheral Interface Adaptor Enable) signals.

DATA BUS BUFFER

Refer to the Data Buffer Schematic Diagram (2-2).

Two chips serve to bidirectionally buffer the data bus. A low RWOC (Read/Write Open Collector) signal from the 4051 enables the buffers to pass signals on the data bus from the 4051 to the ROM Expander. A low ENABLE signal from the ROM Expander Control board enables the buffers to pass signals on the data bus from the ROM Expander to the 4051. The RWOC signal and the ENABLE signal can never be simultaneously low. The ENABLE signal is pulled up on the Buffer board to prevent data transmission to the 4051 when the ROM Expander power cord is removed.

CONTROL BOARD

INTRODUCTION

The address bus and the data bus information arrive on the Control board via connectors J38 and J39. Each information bit passes through a 100 ohm resistor to filter out noise.

During the initial power up sequence of the 4051, the 4051 interrogates every bank switch combination to locate addresses where ROM Packs and interfaces are located. These addresses are stored in memory in the 4051 so that they may be referenced under program control at a later time. The bank switch functions internally to enable ROM Packs and interfaces to respond as reference is made to them.

SLOT SELECTION

Refer to the Slot Select Schematic Diagram (3-1).

The bank switch is controlled by the microprocessor in the 4051 and is addressed at address 87C0 (hex). When a ROM Pack or interface in one of the eight ROM Expander slots is referenced by the 4051, an active low LBS (Load Bank Switch) signal is sent to the Control board of the ROM Expander. There it is gated with the timing signal PIAE (Peripheral Interface Adaptor Enable), an active high PIAE signal that indicates that data on the data bus is valid. This sequence generates a clock that latches data bits DB0, DB1, and DB2 on the output pins of a register. They are then available for decoding by the Slot Decoder.

The Slot Decoder is enabled by the following process. The LBS signal originates in the 4051 Backpack where it latches and decodes data bits DB3, DB4, and DB5. There it generates an active low BSX (Bank Select External) signal that enables the Slot Decoder on the ROM Expander Control board. The binary number on DB0, DB1, and DB2 (being held at inputs A, B, and C of the Slot Decoder) causes one of the eight output signals on the Decoder to go low to indicate which ROM Expander slot was addressed. This output signal selects the appropriate connector to enable the selected ROM Pack or interface in the ROM Expander to put data on the data bus. Refer to Table 4-1 and the Connectors Schematic Diagram (3-3).

Table 4-1
Slot Selection

Binary Number on			Decimal Equivalent	Connector Selected	ROM Expander Address Backpack Slot	
DB2	DB1	DB0			Left	Right
0	0	0	0	J30	41	51
0	0	1	1	J31	42	52
0	1	0	2	J32	43	53
0	1	1	3	J33	44	54
1	0	0	4	J34	45	55
1	0	1	5	J35	46	56
1	1	0	6	J36	47	57
1	1	1	7	J37	48	58

When an interface in a slot of the ROM Expander is addressed, the address is decoded in the 4051 Firmware Backpack or in a Communication Backpack and sent to the ROM Expander Control board on one of three signal lines—XPC2 (External Peripheral Control), XPC3, or XPC4. Each of these signals is ANDed with the Slot Decoder output lines (see Connectors Schematic Diagram, 3-3) to enable the specific ROM Expander slot designated by the 4051 bank switch. XPC2, XPC3, and XPC4 are also ORed to form the XPCS (External Peripheral Control Select) signal. This signal goes active high if an interface in the ROM Expander has been addressed (XPC2, XPC3, or XPC4 active low).

Circuit Description

BUS ENABLE

Refer to the Bus Enable Schematic Diagram (3-2).

The state of the most significant bits of the address bus (AB11, AB12, AB13, AB14, and AB15) is decoded to determine whether the 4051 microprocessor has addressed a code within the ROM bank space. The ROM bank space is a section (8800—A7FF) within the microprocessor address space that is reserved for assembly language programming code in removable ROM Packs. AB14, AB15, and the BSX (Bank Select External) signal enable the Address Decoder to decode the signal lines AB11, AB12, and AB13.

The binary bit pattern on signal lines AB11, AB12, and AB13 is decoded to cause one of eight output signals on the Address Decoder to go active low. Since only four of these output signals are relevant for the ROM bank address, only these four are shown on the schematic diagram. The output from each pin on the Address Decoder represents the decoding of 2K of the ROM bank address space. These outputs are ORed to form one signal, which is active high if the microprocessor has addressed a ROM bank within the ROM Expander. This signal is ORed with the XPCS (External Peripheral Control Select) signal to output an active low signal if either an interface or a ROM bank in the ROM Expander has been addressed. The resulting signal is ANDed with the BSX (Bank Select External) signal to send a signal to AND with the RWOC (Read/Write Open Collector) signal. The resultant low ENABLE signal, sent to the Buffer board, allows the data bus to read from the addressed ROM Expander slot.

REPLACEABLE ELECTRICAL PARTS

PARTS ORDERING INFORMATION

Replacement parts are available from or through your local Tektronix, Inc. Field Office or representative.

Changes to Tektronix instruments are sometimes made to accommodate improved components as they become available, and to give you the benefit of the latest circuit improvements developed in our engineering department. It is therefore important, when ordering parts, to include the following information in your order: Part number, instrument type or number, serial number, and modification number if applicable.

If a part you have ordered has been replaced with a new or improved part, your local Tektronix, Inc. Field Office or representative will contact you concerning any change in part number.

Change information, if any, is located at the rear of this manual.

SPECIAL NOTES AND SYMBOLS

X000 Part first added at this serial number
00X Part removed after this serial number

ITEM NAME

In the Parts List, an Item Name is separated from the description by a colon (:). Because of space limitations, an Item Name may sometimes appear as incomplete. For further Item Name identification, the U.S. Federal Cataloging Handbook H6-1 can be utilized where possible.

ABBREVIATIONS

ACTR	ACTUATOR	PLSTC	PLASTIC
ASSY	ASSEMBLY	QTZ	QUARTZ
CAP	CAPACITOR	RECP	RECEPTACLE
CER	CERAMIC	RES	RESISTOR
CKT	CIRCUIT	RF	RADIO FREQUENCY
COMP	COMPOSITION	SEL	SELECTED
CONN	CONNECTOR	SEMICOND	SEMICONDUCTOR
ELCTLT	ELECTROLYTIC	SENS	SENSITIVE
ELEC	ELECTRICAL	VAR	VARIABLE
INCAND	INCANDESCENT	WW	WIREWOUND
LED	LIGHT EMITTING DIODE	XFMR	TRANSFORMER
NONWIR	NON WIREWOUND	XTAL	CRYSTAL

CROSS INDEX—MFR. CODE NUMBER TO MANUFACTURER

Mfr. Code	Manufacturer	Address	City, State, Zip
01121	ALLEN-BRADLEY COMPANY	1201 2ND STREET SOUTH	MILWAUKEE, WI 53204
01295	TEXAS INSTRUMENTS, INC., SEMICONDUCTOR GROUP	P O BOX 5012, 13500 N CENTRAL EXPRESSWAY	DALLAS, TX 75222
02777	HOPKINS ENGINEERING COMPANY	12900 FOOTHILL BLVD.	SAN FERNANDO, CA 91342
04713	MOTOROLA, INC., SEMICONDUCTOR PROD. DIV.	5005 E MCDOWELL RD, PO BOX 20923	PHOENIX, AZ 85036
05574	VIKING INDUSTRIES, INC.	21001 NORDHOFF STREET	CHATSWORTH, CA 91311
27014	NATIONAL SEMICONDUCTOR CORP.	2900 SEMICONDUCTOR DR.	SANTA CLARA, CA 95051
56289	SPRAGUE ELECTRIC CO.		NORTH ADAMS, MA 01247
71400	BUSSMAN MFG., DIVISION OF MCGRAW-EDISON CO.	2536 W. UNIVERSITY ST.	ST. LOUIS, MO 63107
80009	TEKTRONIX, INC.	P O BOX 500	BEAVERTON, OR 97077
82877	ROTRON, INC.	7-9 HASBROUCK LANE	WOODSTOCK, NY 12498
90201	MALLORY CAPACITOR CO., DIV. OF P. R. MALLORY AND CO., INC.	3029 E. WASHINGTON STREET P. O. BOX 372	INDIANAPOLIS, IN 46206

Ckt No.	Tektronix Part No.	Serial/Model No. Eff	Dscont	Name & Description	Mfr Code	Mfr Part Number
CIRCUIT BOARD ASSEMBLIES						
A1	670-4786-00			CKT BOARD ASSY:POWER SUPPLY	80009	670-4786-00
A2	670-4398-00	B010100	B020198	CKT BOARD ASSY:ROM EXTENDER BUFFER	80009	670-4398-00
A2	670-4398-01	B020199		CKT BOARD ASSY:ROM EXTENDER BUFFER	80009	670-4398-01
A2	670-4398-01			CKT BOARD ASSY:ROM EXTENDER BUFFER	80009	670-4398-01
A3	670-4787-00			CKT BOARD ASSY:CONTROL	80009	670-4787-00
A1 POWER SUPPLY ASSEMBLY						
A1	670-4786-00			CKT BOARD ASSY:POWER SUPPLY	80009	670-4786-00
C1	290-0770-00			CAP., FXD, ELCTLT:100UF,+50-10%,25V	56289	502D230
C11	290-0770-00			CAP., FXD, ELCTLT:100UF,+50-10%,25V	56289	502D230
C21	290-0770-00			CAP., FXD, ELCTLT:100UF,+50-10%,25V	56289	502D230
C31	290-0770-00			CAP., FXD, ELCTLT:100UF,+50-10%,25V	56289	502D230
C101	290-0508-00			CAP., FXD, ELCTLT:18,000UF,+100-10%,15V	56289	68D10444
C131	290-0753-00			CAP., FXD, ELCTLT:4500UF,+75-10%,30V	90201	20-30431
C231	290-0753-00			CAP., FXD, ELCTLT:4500UF,+75-10%,30V	90201	20-30431
CR201	152-0198-00			SEMICONV DEVICE:SILICON,200V,3A	04713	1N4721
CR202	152-0198-00			SEMICONV DEVICE:SILICON,200V,3A	04713	1N4721
CR203	152-0406-00			SEMICONV DEVICE:SILICON,200V,3A	80009	152-0406-00
A2 ROM EXTENDER BUFFER ASSEMBLY						
A2	670-4398-00	B010100	B020198	CKT BOARD ASSY:ROM EXTENDER BUFFER	80009	670-4398-00
A2	670-4398-01	B020199		CKT BOARD ASSY:ROM EXTENDER BUFFER	80009	670-4398-01
C5	283-0010-00			CAP., FXD, CER DI:0.05UF,+100-20%,50V	56289	273C20
C15	283-0010-00			CAP., FXD, CER DI:0.05UF,+100-20%,50V	56289	273C20
C25	283-0010-00			CAP., FXD, CER DI:0.05UF,+100-20%,50V	56289	273C20
C35	283-0010-00			CAP., FXD, CER DI:0.05UF,+100-20%,50V	56289	273C20
C205	290-0745-00			CAP., FXD, ELCTLT:22UF,+50-10%,25V	56289	502D225
R110	317-0750-00	XB020199		RES., FXD, CMPSN:75 OHM,5%,0.125W	01121	BB7505
R112	317-0750-00	XB020199		RES., FXD, CMPSN:75 OHM,5%,0.125W	01121	BB7505
R114	317-0750-00	XB020199		RES., FXD, CMPSN:75 OHM,5%,0.125W	01121	BB7505
R116	317-0750-00	XB020199		RES., FXD, CMPSN:75 OHM,5%,0.125W	01121	BB7505
R120	317-0750-00	XB020199		RES., FXD, CMPSN:75 OHM,5%,0.125W	01121	BB7505
R122	317-0750-00	XB020199		RES., FXD, CMPSN:75 OHM,5%,0.125W	01121	BB7505
R124	317-0750-00	XB020199		RES., FXD, CMPSN:75 OHM,5%,0.125W	01121	BB7505
R126	317-0750-00	XB020199		RES., FXD, CMPSN:75 OHM,5%,0.125W	01121	BB7505
R135	315-0102-00			RES., FXD, CMPSN:1K OHM,5%,0.25W	01121	CB1025
U5	156-0852-00			MICROCIRCUIT,DI:HEX BUS DRIVER W/3-STATE	T 01295	SN74L5367N
U15	156-0852-00			MICROCIRCUIT,DI:HEX BUS DRIVER W/3-STATE	T 01295	SN74L5367N
U25	156-0852-00			MICROCIRCUIT,DI:HEX BUS DRIVER W/3-STATE	T 01295	SN74L5367N
U35	156-0852-00			MICROCIRCUIT,DI:HEX BUS DRIVER W/3-STATE	T 01295	SN74L5367N
U115	156-0531-00			MICROCIRCUIT,DI:QUAD UNIFIED BUS XCVR	27014	DM8833N
U125	156-0531-00			MICROCIRCUIT,DI:QUAD UNIFIED BUS XCVR	27014	DM8833N
A3 CONTROL ASSEMBLY						
A3	670-4787-00			CKT BOARD ASSY:CONTROL	80009	670-4787-00
C30	290-0745-00			CAP., FXD, ELCTLT:22UF,+50-10%,25V	56289	502D225

Replaceable Electrical Parts—4051E01

Ckt No.	Tektronix Part No.	Serial/Model No. Eff	Dscont	Name & Description	Mfr Code	Mfr Part Number
C31	290-0745-00			CAP., FXD, ELCTLT: 22UF, +50-10%, 25V	56289	502D225
C32	290-0745-00			CAP., FXD, ELCTLT: 22UF, +50-10%, 25V	56289	502D225
C33	290-0745-00			CAP., FXD, ELCTLT: 22UF, +50-10%, 25V	56289	502D225
C201	283-0010-00			CAP., FXD, CER DI: 0.05UF, +100-20%, 50V	56289	273C20
C221	283-0010-00			CAP., FXD, CER DI: 0.05UF, +100-20%, 50V	56289	273C20
C241	283-0010-00			CAP., FXD, CER DI: 0.05UF, +100-20%, 50V	56289	273C20
C361	283-0010-00			CAP., FXD, CER DI: 0.05UF, +100-20%, 50V	56289	273C20
C572	283-0010-00			CAP., FXD, CER DI: 0.05UF, +100-20%, 50V	56289	273C20
J30	131-1962-00			CONN, RCPT, ELEC: CKT CARD, 22/44 CONT	05574	3VH22/1JV3
J31	131-1962-00			CONN, RCPT, ELEC: CKT CARD, 22/44 CONT	05574	3VH22/1JV3
J32	131-1962-00			CONN, RCPT, ELEC: CKT CARD, 22/44 CONT	05574	3VH22/1JV3
J33	131-1962-00			CONN, RCPT, ELEC: CKT CARD, 22/44 CONT	05574	3VH22/1JV3
J34	131-1962-00			CONN, RCPT, ELEC: CKT CARD, 22/44 CONT	05574	3VH22/1JV3
J35	131-1962-00			CONN, RCPT, ELEC: CKT CARD, 22/44 CONT	05574	3VH22/1JV3
J36	131-1962-00			CONN, RCPT, ELEC: CKT CARD, 22/44 CONT	05574	3VH22/1JV3
J37	131-1962-00			CONN, RCPT, ELEC: CKT CARD, 22/44 CONT	05574	3VH22/1JV3
R60	315-0101-00			RES., FXD, CMPSN: 100 OHM, 5%, 0.25W	01121	CB1015
R61	315-0101-00			RES., FXD, CMPSN: 100 OHM, 5%, 0.25W	01121	CB1015
R62	315-0101-00			RES., FXD, CMPSN: 100 OHM, 5%, 0.25W	01121	CB1015
R63	315-0101-00			RES., FXD, CMPSN: 100 OHM, 5%, 0.25W	01121	CB1015
R160	315-0101-00			RES., FXD, CMPSN: 100 OHM, 5%, 0.25W	01121	CB1015
R161	315-0101-00			RES., FXD, CMPSN: 100 OHM, 5%, 0.25W	01121	CB1015
R162	315-0101-00			RES., FXD, CMPSN: 100 OHM, 5%, 0.25W	01121	CB1015
R163	315-0101-00			RES., FXD, CMPSN: 100 OHM, 5%, 0.25W	01121	CB1015
R164	315-0101-00			RES., FXD, CMPSN: 100 OHM, 5%, 0.25W	01121	CB1015
R165	315-0101-00			RES., FXD, CMPSN: 100 OHM, 5%, 0.25W	01121	CB1015
R172	315-0101-00			RES., FXD, CMPSN: 100 OHM, 5%, 0.25W	01121	CB1015
R173	315-0101-00			RES., FXD, CMPSN: 100 OHM, 5%, 0.25W	01121	CB1015
R174	315-0101-00			RES., FXD, CMPSN: 100 OHM, 5%, 0.25W	01121	CB1015
R251	315-0101-00			RES., FXD, CMPSN: 100 OHM, 5%, 0.25W	01121	CB1015
R253	315-0101-00			RES., FXD, CMPSN: 100 OHM, 5%, 0.25W	01121	CB1015
R255	315-0101-00			RES., FXD, CMPSN: 100 OHM, 5%, 0.25W	01121	CB1015
R261	315-0472-00			RES., FXD, CMPSN: 4.7K OHM, 5%, 0.25W	01121	CB4725
R371	315-0101-00			RES., FXD, CMPSN: 100 OHM, 5%, 0.25W	01121	CB1015
R372	315-0101-00			RES., FXD, CMPSN: 100 OHM, 5%, 0.25W	01121	CB1015
R460	315-0101-00			RES., FXD, CMPSN: 100 OHM, 5%, 0.25W	01121	CB1015
R461	315-0101-00			RES., FXD, CMPSN: 100 OHM, 5%, 0.25W	01121	CB1015
R462	315-0101-00			RES., FXD, CMPSN: 100 OHM, 5%, 0.25W	01121	CB1015
R463	315-0101-00			RES., FXD, CMPSN: 100 OHM, 5%, 0.25W	01121	CB1015
R464	315-0101-00			RES., FXD, CMPSN: 100 OHM, 5%, 0.25W	01121	CB1015
R465	315-0101-00			RES., FXD, CMPSN: 100 OHM, 5%, 0.25W	01121	CB1015
R470	315-0101-00			RES., FXD, CMPSN: 100 OHM, 5%, 0.25W	01121	CB1015
R471	315-0101-00			RES., FXD, CMPSN: 100 OHM, 5%, 0.25W	01121	CB1015
R472	315-0101-00			RES., FXD, CMPSN: 100 OHM, 5%, 0.25W	01121	CB1015
R473	315-0101-00			RES., FXD, CMPSN: 100 OHM, 5%, 0.25W	01121	CB1015
U201	156-0479-00			MICROCIRCUIT, DI: QUAD 2-INPUT OR GATE	27014	DM74LS32N
U221	156-0479-00			MICROCIRCUIT, DI: QUAD 2-INPUT OR GATE	27014	DM74LS32N
U241	156-0479-00			MICROCIRCUIT, DI: QUAD 2-INPUT OR GATE	27014	DM74LS32N
U261	156-0392-00			MICROCIRCUIT, DI: QUAD LATCH	80009	156-0392-00
U262	156-0469-00			MICROCIRCUIT, DI: 3-LINE TO 8-LINE DECODER	01295	SN74LS138N
U301	156-0479-00			MICROCIRCUIT, DI: QUAD 2-INPUT OR GATE	27014	DM74LS32N
U321	156-0479-00			MICROCIRCUIT, DI: QUAD 2-INPUT OR GATE	27014	DM74LS32N
U341	156-0479-00			MICROCIRCUIT, DI: QUAD 2-INPUT OR GATE	27014	DM74LS32N
U361	156-0382-00			MICROCIRCUIT, DI: QUAD 2-INPUT NAND GATE	80009	156-0382-00
U472	156-0383-00			MICROCIRCUIT, DI: QUAD 2-INPUT NOR GATE	80009	156-0383-00

Replaceable Electrical Parts—4051E01

Ckt No.	Tektronix Part No.	Serial/Model No. Eff	Dscont	Name & Description	Mfr Code	Mfr Part Number
U571	156-0469-00			MICROCIRCUIT,DI:3-LINE TO 8-LINE DECODER	01295	SN74LS138N
U572	156-0464-00			MICROCIRCUIT,DI:DUAL 4-INPUT NAND GATE	80009	156-0464-00
CHASSIS PARTS						
A1001	119-0813-00			SELECTOR,VOLTS:W/LINE FLTR RCPT & FUSE	02777	F65003
B1007	119-0492-00			FAN,AXIAL:MUFFIN TYPE,3 INCH DIA,115V	82877	SU2C5
F1003	159-0018-00			FUSE,CARTRIDGE:3AG,0.8A,250V,SLOW-BLOW (FOR 110V - 120V OPERATION ONLY)	71400	MDL 8/10
F1003	159-0031-00			FUSE,CARTRIDGE:3AG,0.4A,250V,SLOW-BLOW (FOR 220V - 240V OPERATION ONLY)	71400	MDL 4/10
K1005	148-0091-00			RELAY,ARMATURE:4 FORM C,6VDC,2A,125VAC	80009	148-0091-00
Q1	156-0277-00			MICROCIRCUIT,LI:VOLTAGE REGULATOR	80009	156-0277-00
Q11	156-0277-00			MICROCIRCUIT,LI:VOLTAGE REGULATOR	80009	156-0277-00
Q21	156-0285-00			MICROCIRCUIT,LI:VOLTAGE REGULATOR	80009	156-0285-00
Q31	156-0872-00			MICROCIRCUIT,LI:VOLTAGE REGULATOR	80009	156-0872-00
T1009	120-1098-00			XFMR,PWR,STPDN:	80009	120-1098-00

DIAGRAMS

Section 6

SCHMATIC INDEX	Diagram No.
Power Supply	1-1
Buffer Board Address	2-1
Buffer Board Data	2-2
Control Board Slot Select	3-1
Control Board Bus Enable	3-2
Control Board Connectors	3-3

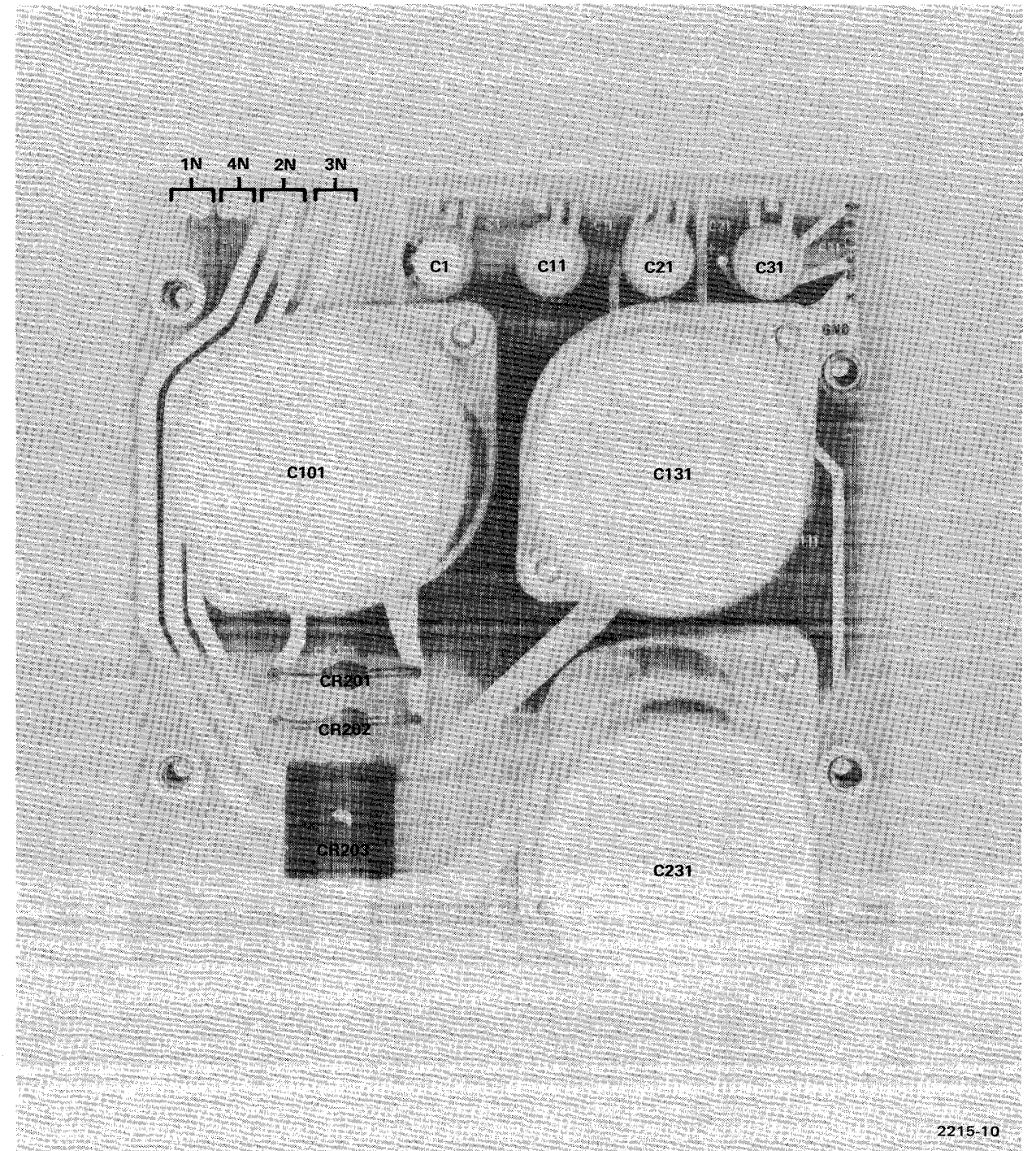

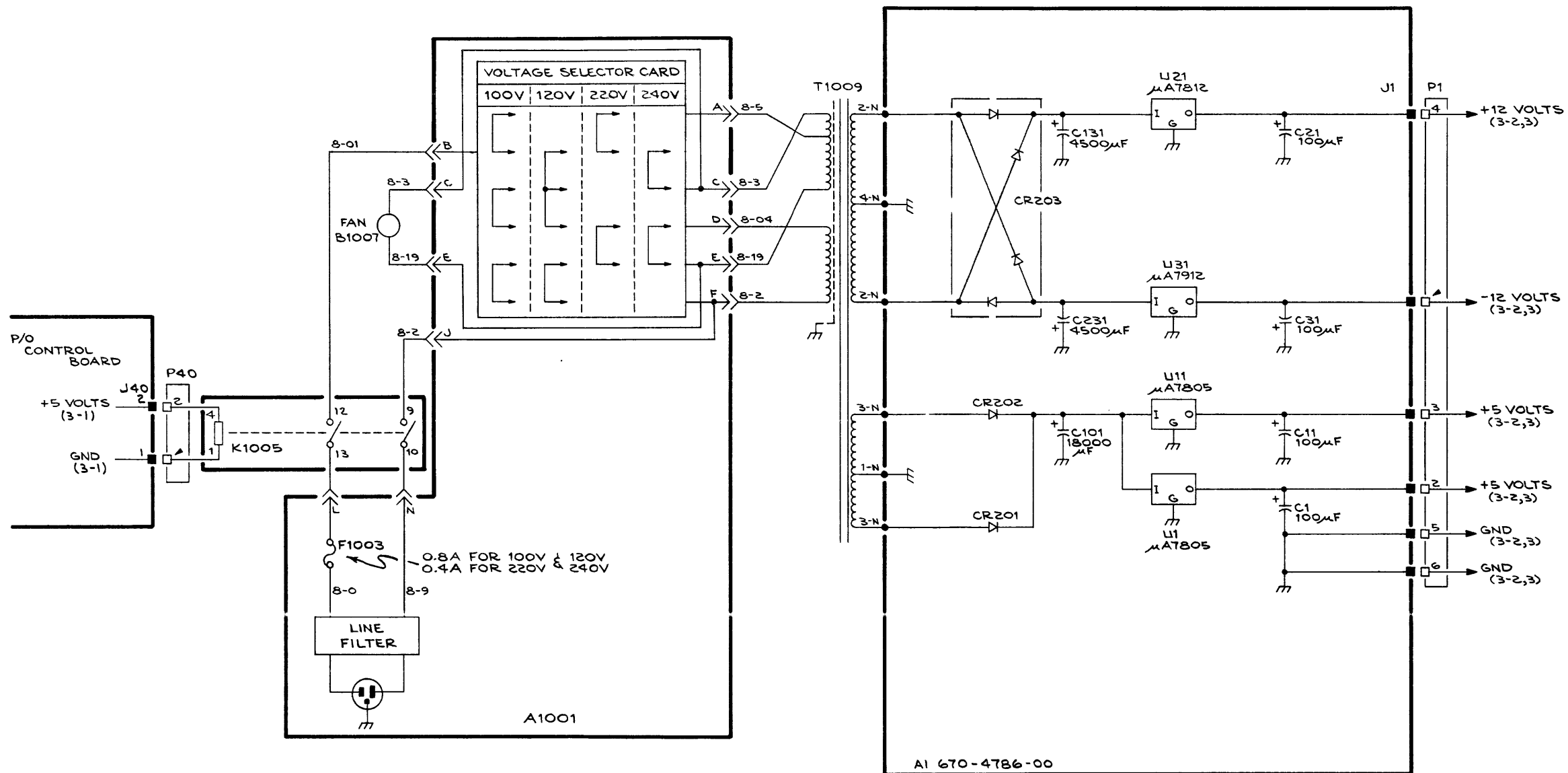

POWER SUPPLY

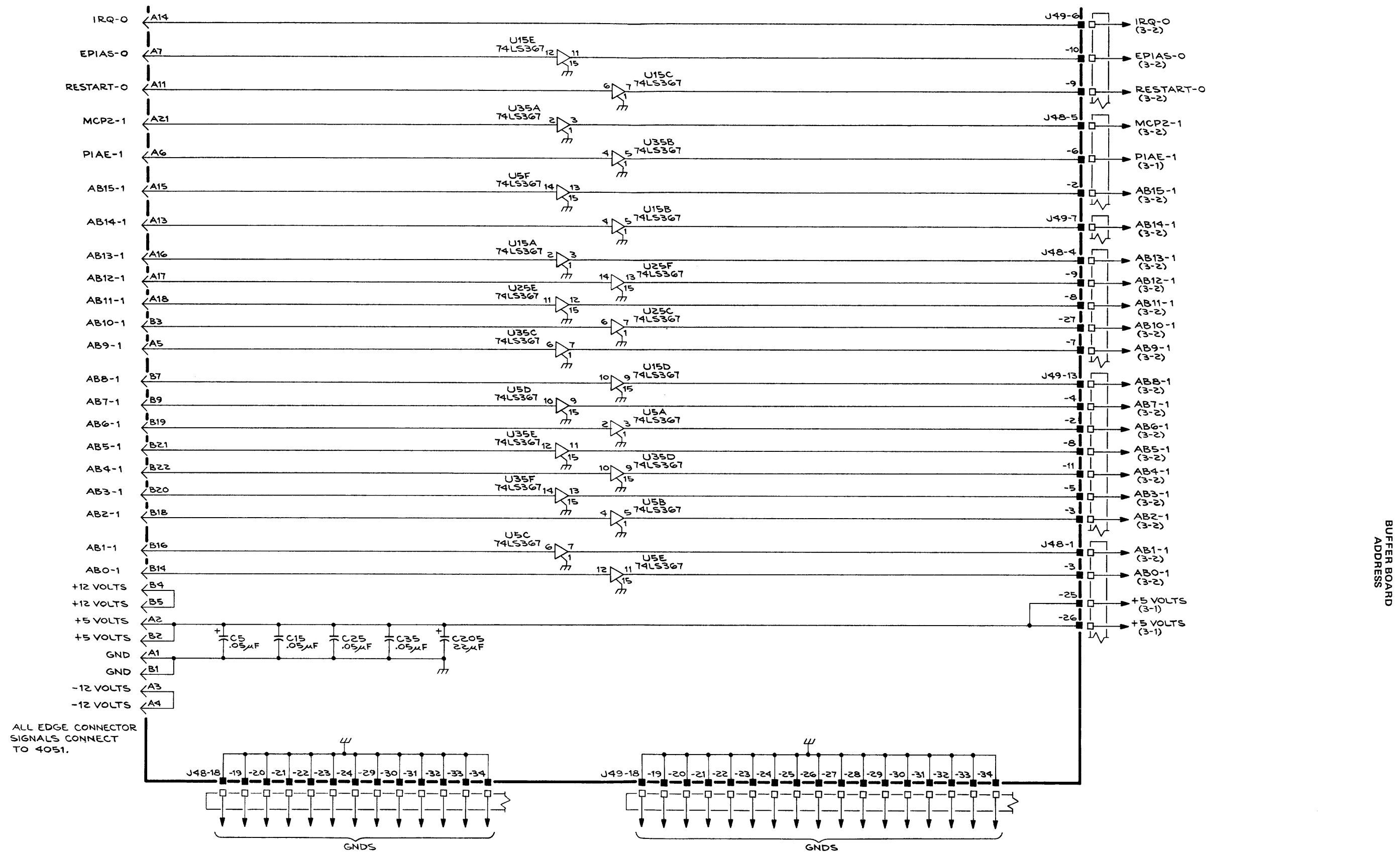

4051E01

ROM EXPANDER ADDRESS
BUFFER BOARD 2-1

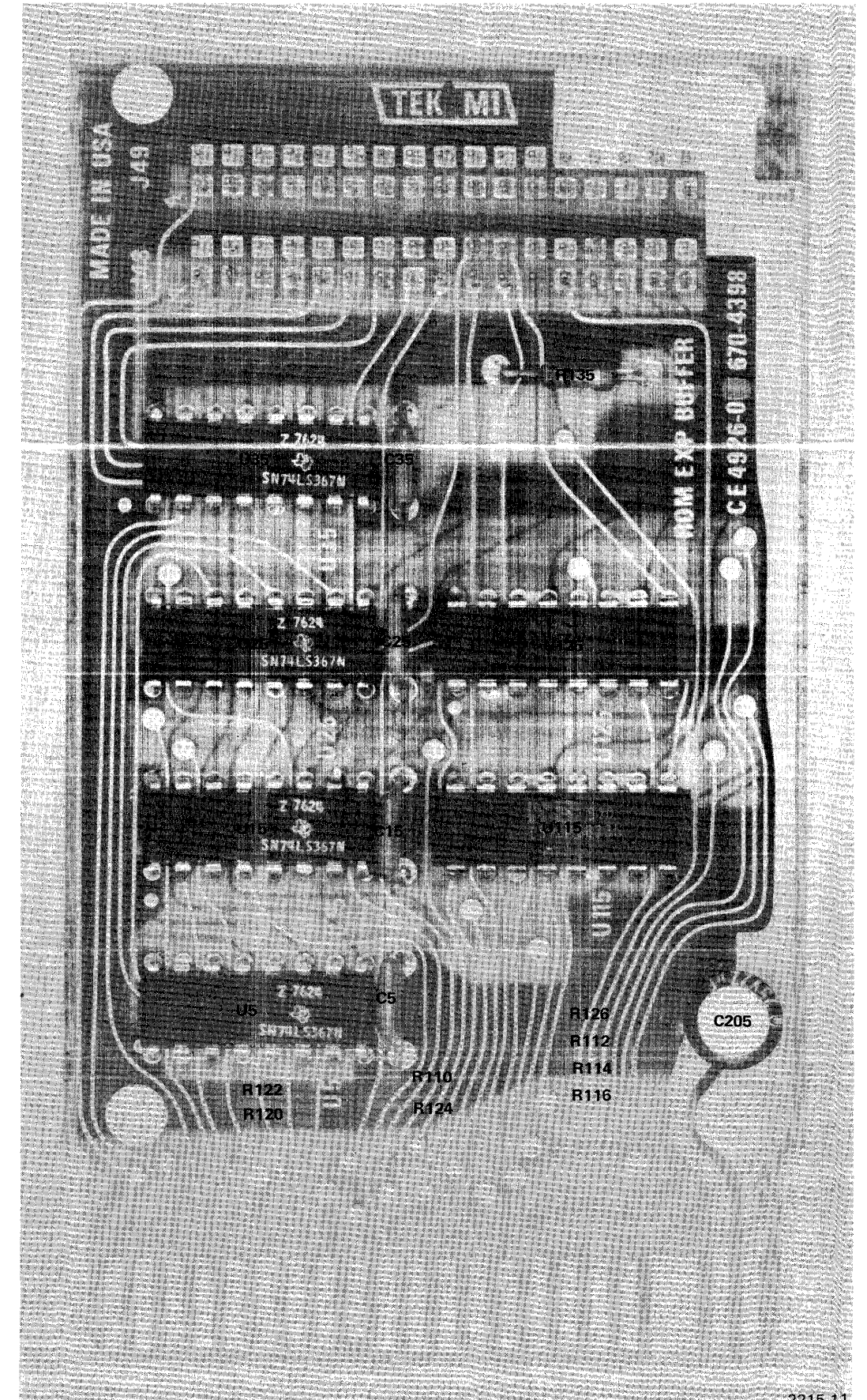

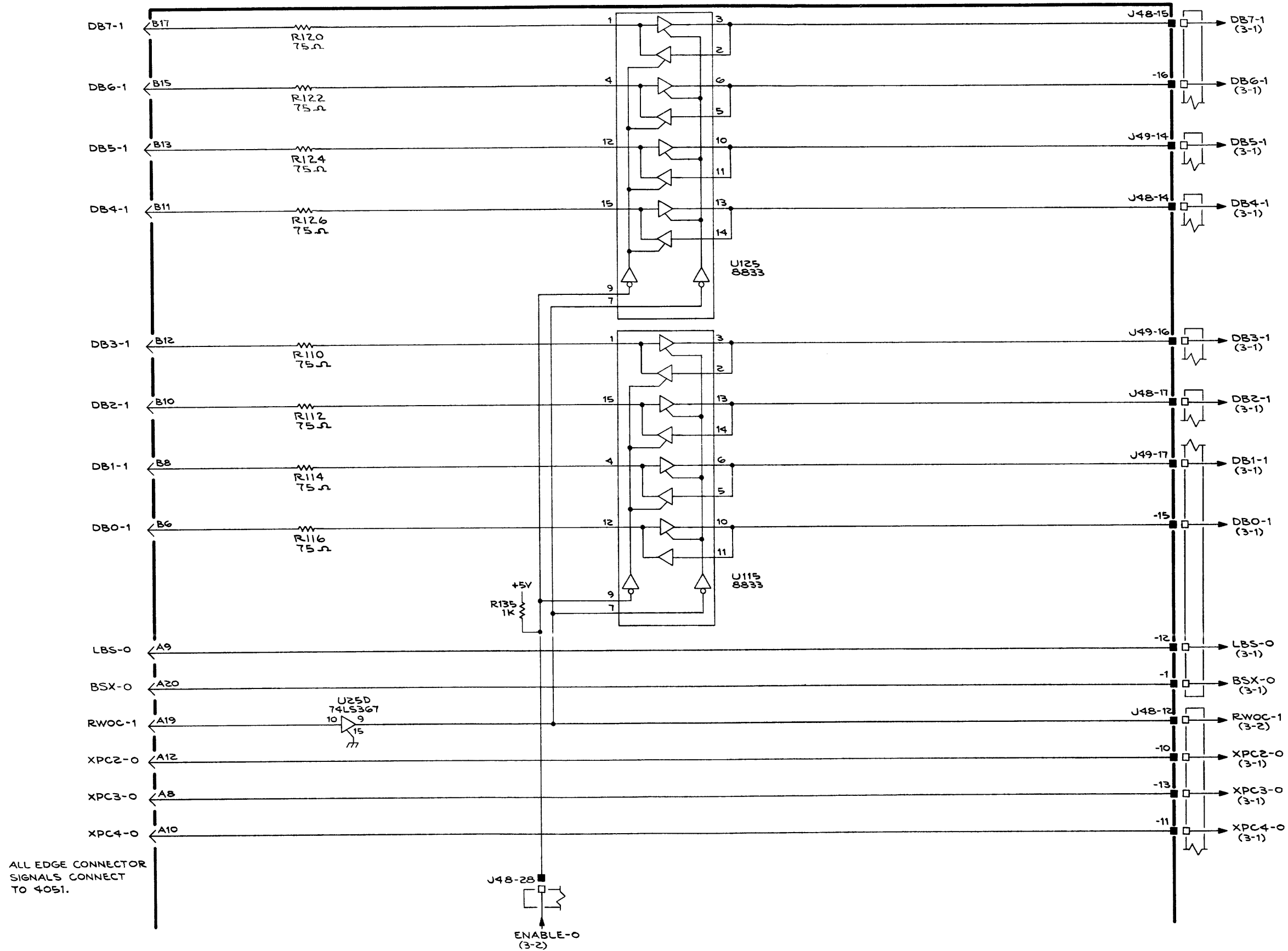

ALL EDGE CONNECTOR SIGNALS CONNECT TO 4051.

4051E01

2215-15
REV A, MAR 1979

ROM EXPANDER DATA
BUFFER BOARD 2-2

BUFFER BOARD
DATA

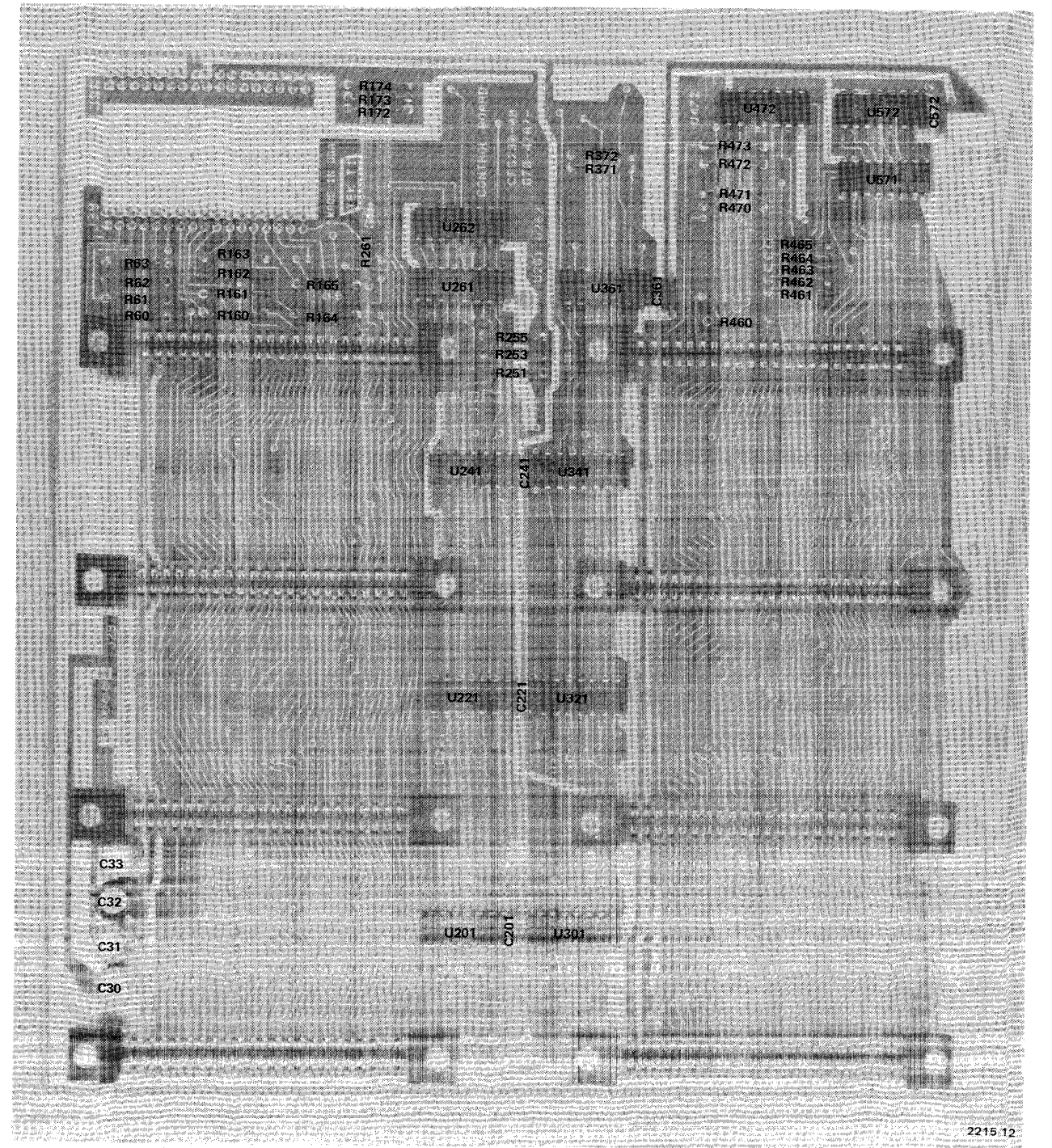

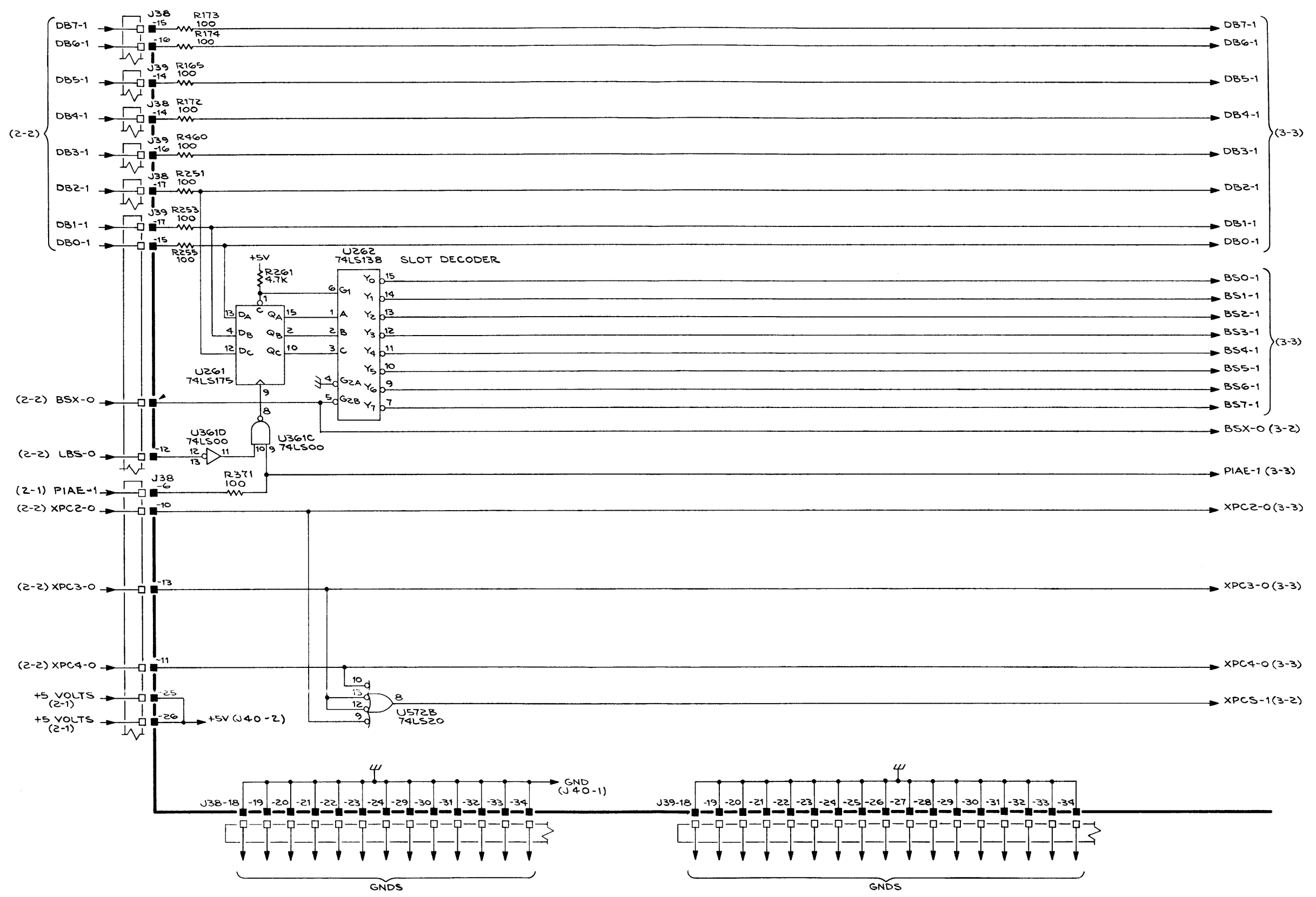

4051E01

2215-16
REV A, MAR 1979

ROM EXPANDER SLOT SELECT
CONTROL BOARD 3-1

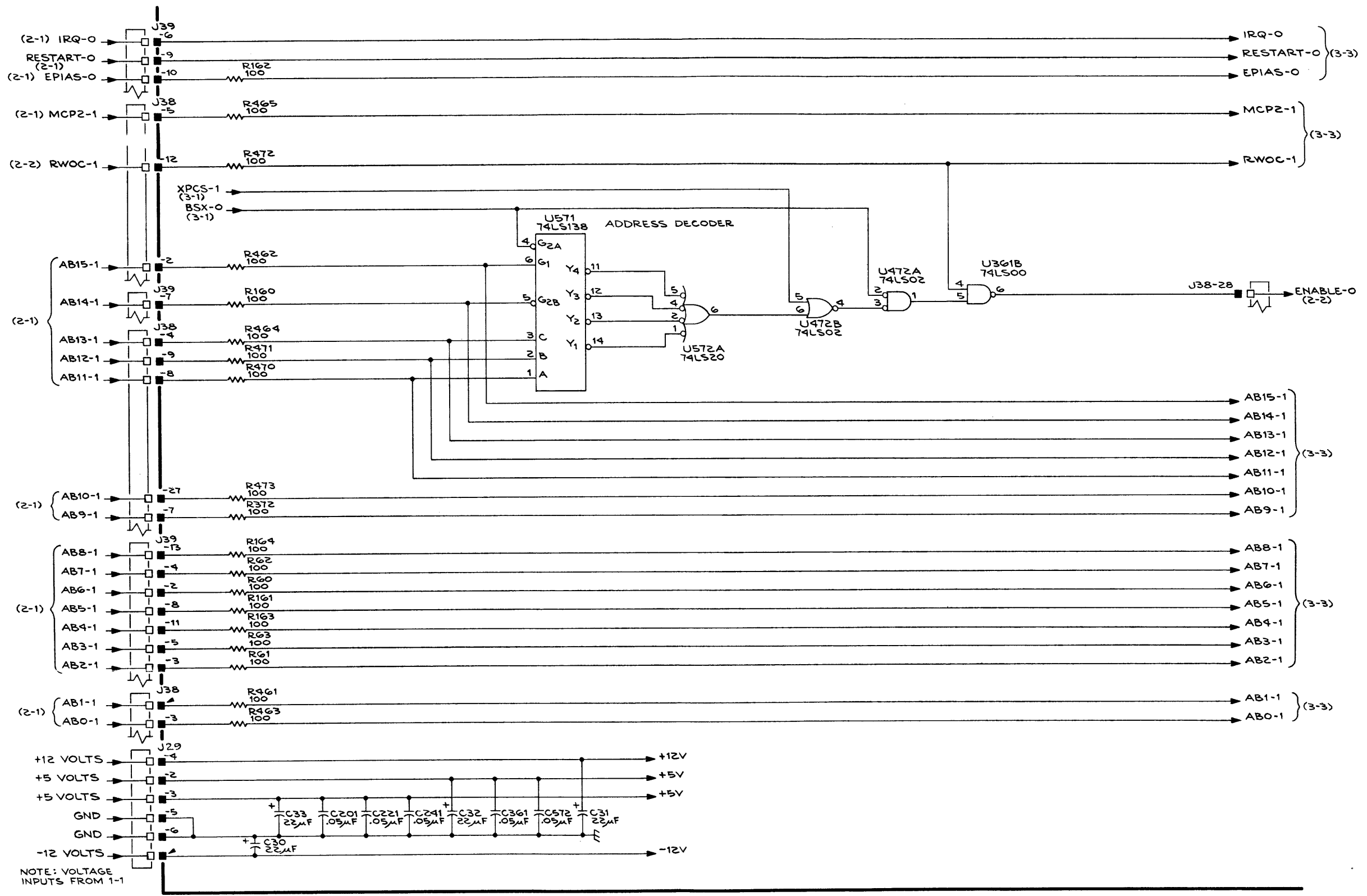

CONTROL BOARD
BUS ENABLE

4051E01

2215-17
REVA, MAR 1979

ROM EXPANDER BUS ENABLE
CONTROL BOARD 3-2

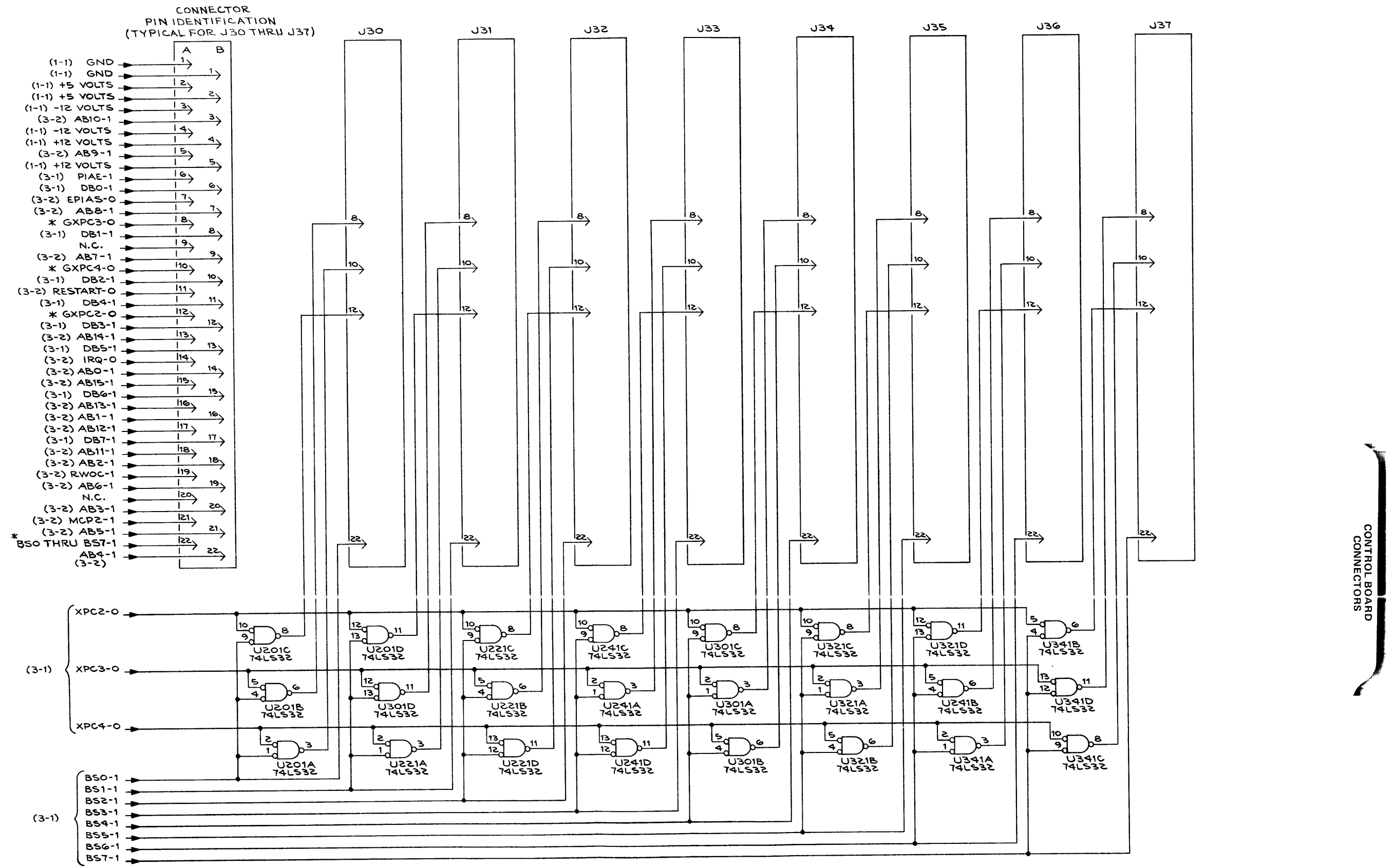

* THESE SIGNAL LINES ARE INCLUDED ON
THIS DIAGRAM FOR PIN IDENTIFICATION ONLY.

4051E01

2215-18
REVA, MAR 1979

ROM EXPANDER CONNECTORS
CONTROL BOARD 3-3

REPLACEABLE MECHANICAL PARTS

PARTS ORDERING INFORMATION

Replacement parts are available from or through your local Tektronix, Inc. Field Office or representative.

Changes to Tektronix instruments are sometimes made to accommodate improved components as they become available, and to give you the benefit of the latest circuit improvements developed in our engineering department. It is therefore important, when ordering parts, to include the following information in your order: Part number, instrument type or number, serial number, and modification number if applicable.

If a part you have ordered has been replaced with a new or improved part, your local Tektronix, Inc. Field Office or representative will contact you concerning any change in part number.

Change information, if any, is located at the rear of this manual.

SPECIAL NOTES AND SYMBOLS

X000 Part first added at this serial number
00X Part removed after this serial number

FIGURE AND INDEX NUMBERS

Items in this section are referenced by figure and index numbers to the illustrations.

INDENTATION SYSTEM

This mechanical parts list is indented to indicate item relationships. Following is an example of the indentation system used in the description column.

```

1 2 3 4 5           Name & Description
Assembly and/or Component
Attaching parts for Assembly and/or Component
  --- * ---
Detail Part of Assembly and/or Component
Attaching parts for Detail Part
  --- * ---
Parts of Detail Part
Attaching parts for Parts of Detail Part
  --- * ---
  
```

Attaching Parts always appear in the same indentation as the item it mounts, while the detail parts are indented to the right. Indented items are part of, and included with, the next higher indentation. The separation symbol --- * --- indicates the end of attaching parts.

Attaching parts must be purchased separately, unless otherwise specified.

ITEM NAME

In the Parts List, an Item Name is separated from the description by a colon (:). Because of space limitations, an Item Name may sometimes appear as incomplete. For further Item Name identification, the U.S. Federal Cataloging Handbook H6-1 can be utilized where possible.

ABBREVIATIONS

"	INCH	ELCTRN	ELECTRON	IN	INCH	SE	SINGLE END
#	NUMBER SIZE	ELEC	ELECTRICAL	INCAND	INCANDESCENT	SECT	SECTION
ACTR	ACTUATOR	ELCTLT	ELECTROLYTIC	INSUL	INSULATOR	SEMICOND	SEMICONDUCTOR
ADPTR	ADAPTER	ELEM	ELEMENT	INTL	INTERNAL	SHLD	SHIELD
ALIGN	ALIGNMENT	EPL	ELECTRICAL PARTS LIST	LPHLDR	LAMPHOLDER	SHLDR	SHOULDERED
AL	ALUMINUM	EOPT	EQUIPMENT	MACH	MACHINE	SKT	SOCKET
ASSEM	ASSEMBLED	EXT	EXTERNAL	MECH	MECHANICAL	SL	SLIDE
ASSY	ASSEMBLY	FIL	FILLISTER HEAD	MTG	MOUNTING	SLFLKG	SELF-LOCKING
ATTEN	ATTENUATOR	FLEX	FLEXIBLE	NIP	NIPPLE	SLVG	SLEEVEING
AWG	AMERICAN WIRE GAGE	FLH	FLAT HEAD	NON WIRE	NOT WIRE WOUND	SPR	SPRING
BD	BOARD	FLTR	FILTER	OBD	ORDER BY DESCRIPTION	SQ	SQUARE
BRKT	BRACKET	FR	FRAME or FRONT	OD	OUTSIDE DIAMETER	SST	STAINLESS STEEL
BR	BRASS	FSTNR	FASTENER	OVB	OVAL HEAD	STL	STEEL
BRZ	BRONZE	FT	FOOT	PH BRZ	PHOSPHOR BRONZE	SW	SWITCH
BSHG	BUSHING	FXD	FIXED	PL	PLAIN or PLATE	T	TUBE
CAB	CABINET	GSKT	GASKET	PLSTC	PLASTIC	TERM	TERMINAL
CAP	CAPACITOR	HDL	HANDLE	PN	PART NUMBER	THD	THREAD
CER	CERAMIC	HEX	HEXAGON	PNH	PAN HEAD	THK	THICK
CHAS	CHASSIS	HEX HD	HEXAGONAL HEAD	PWR	POWER	TNSN	TENSION
CKT	CIRCUIT	HEX SOC	HEXAGONAL SOCKET	RCPT	RECEPTACLE	TPG	TAPPING
COMP	COMPOSITION	HLCPS	HELICAL COMPRESSION	RES	RESISTOR	TRH	TRUSS HEAD
CONN	CONNECTOR	HLEXT	HELICAL EXTENSION	RGD	RIGID	V	VOLTAGE
COV	COVER	HV	HIGH VOLTAGE	RLF	RELIEF	VAR	VARIABLE
CPLG	COUPLING	IC	INTEGRATED CIRCUIT	RTNR	RETAINER	W/	WITH
CRT	CATHODE RAY TUBE	ID	INSIDE DIAMETER	SCH	SOCKET HEAD	WSHR	WASHER
DEG	DEGREE	IDNT	IDENTIFICATION	SCOPE	OSCILLOSCOPE	XFMR	TRANSFORMER
DWR	DRAWER	IMPLR	IMPELLER	SCR	SCREW	XSTR	TRANSISTOR

CROSS INDEX—MFR. CODE NUMBER TO MANUFACTURER

Mfr. Code	Manufacturer	Address	City, State, Zip
00779	AMP, INC.	P O BOX 3608	HARRISBURG, PA 17105
02777	HOPKINS ENGINEERING COMPANY	12900 FOOTHILL BLVD.	SAN FERNANDO, CA 91342
05574	VIKING INDUSTRIES, INC.	21001 NORDHOFF STREET	CHATSWORTH, CA 91311
08261	SPECTRA-STRIP CORP.	7100 LAMPSON AVE.	GARDEN GROVE, CA 92642
12327	FREEWAY CORPORATION	9301 ALLEN DRIVE	CLEVELAND, OH 44125
22526	BERG ELECTRONICS, INC.	YOUK EXPRESSWAY	NEW CUMBERLAND, PA 17070
52905	SIMPLEX MFG. COMPANY	5224 NE 42ND AVENUE	PORTLAND, OREGON 97218
53387	MINNESOTA MINING AND MFG. CO., ELECTRO PRODUCTS DIVISION	3M CENTER	ST. PAUL, MN 55101
56289	SPRAGUE ELECTRIC CO.		NORTH ADAMS, MA 01247
73743	FISCHER SPECIAL MFG. CO.	446 MORGAN ST.	CINCINNATI, OH 45206
77250	PHEOLL MANUFACTURING CO., DIVISION OF ALLIED PRODUCTS CORP.	5700 W. ROOSEVELT RD.	CHICAGO, IL 60650
77342	AMF INC., POTTER AND BRUMFIELD DIV.	200 RICHLAND CREEK DRIVE	PRINCETON, IN 47671
77969	RUBBERCRAFT CORP. OF CALIF., LTD.	1800 W. 220TH ST.	TORRANCE, CA 90507
78189	ILLINOIS TOOL WORKS, INC. SHAKEPROOF DIVISION	ST. CHARLES ROAD	ELGIN, IL 60120
80009	TEKTRONIX, INC.	P O BOX 500	BEAVERTON, OR 97077
82877	ROTRON, INC.	7-9 HASBROUCK LANE	WOODSTOCK, NY 12498
83385	CENTRAL SCREW CO.	2530 CRESCENT DR.	BROADVIEW, IL 60153
86445	PENN FIBRE AND SPECIALTY CO., INC.	2032 E. WESTMORELAND ST.	PHILADELPHIA, PA 19134
90201	MALLORY CAPACITOR CO., DIV. OF P. R. MALLORY AND CO., INC.	3029 E. WASHINGTON STREET P. O. BOX 372	INDIANAPOLIS, IN 46206
98627	UNIVERSAL OIL PRODUCTS CO., MORPLEX DIV.	1300 MORPLEX DRIVE	LACROSSE, WI 54601

Fig. & Index No.	Tektronix Part No.	Serial/Model No. Eff Dscont	Qty	1 2 3 4 5	Name & Description	Mfr Code	Mfr Part Number
1-	644-0105-00		1		CAB. TOP ASSY: (ATTACHING PARTS)	80009	644-0105-00
-1	211-0559-00		4		SCREW,MACHINE:6-32 X 0.375"100 DEG,FLH STL - - - * - - -	83385	OBD
-2	407-1892-00		2		. BRACKET,CAB.TOP:HOLD DOWN,ALUMINUM (ATTACHING PARTS FOR EACH)	80009	407-1892-00
-3	210-0457-00		2		. NUT,PLAIN,EXT W:6-32 X 0.312 INCH,STL - - - * - - -	83385	OBD
-4	407-1363-00		8		. BRACKET,HINGE:ALUMINUM (ATTACHING PARTS FOR EACH)	80009	407-1363-00
-5	210-0586-00		2		. NUT,PLAIN,EXT W:4-40 X 0.25 INCH,STL - - - * - - -	78189	211-041800-00
-6	214-1905-00		8		. PIN,HINGE:0.062 DIA X 2.850" L,SST	80009	214-1905-00
-7	214-1906-00		8		. SPR,HLCL,TRSN:0.108 DIA X 1.250 INCH LONG	80009	214-1906-00
-8	200-1575-01		8		. LID,ROM HOUSING:	80009	200-1575-01
-9	390-0557-00		1		. CABINET TOP:	80009	390-0557-00
-10	334-3003-00		1		MARKER, IDENT:	80009	334-3003-00
-11	200-2041-00		1		COVER,PWR SPLY: (ATTACHING PARTS)	80009	200-2041-00
-12	211-0504-00		4		SCREW,MACHINE:6-32 X 0.25 INCH,PNH STL - - - * - - -	83385	OBD
	634-0417-00		2		ROM GUIDE ASSY: (ATTACHING PARTS FOR EACH)	80009	634-0417-00
-13	211-0504-00		4		SCREW,MACHINE:6-32 X 0.25 INCH,PNH STL - - - * - - -	83385	OBD
	-----		-		. EACH GUIDE ASSY INCLUDES:		
-14	351-0511-00		4		. GUIDE,ROM: (ATTACHING PARTS)	80009	351-0511-00
-15	211-0012-00		8		. SCREW,MACHINE:4-40 X 0.375 INCH,PNH STL - - - * - - -	83385	OBD
-16	380-0336-01		4		. HOUSING,ROM:ALUMINUM	80009	380-0336-01
-17	386-3664-00		1		. SPRT,ROM HSG:	80009	386-3664-00
-18	343-0685-00		1		CLAMP,CABLE: (ATTACHING PARTS)	80009	343-0685-00
-19	211-0014-00		2		SCREW,MACHINE:4-40 X 0.50 INCH,PNH STL	83385	OBD
-20	210-0586-00		2		NUT,PLAIN,EXT W:4-40 X 0.25 INCH,STL - - - * - - -	78189	211-041800-00
-21	252-0571-00		FT		NEOPRENE EXTR:CHAN,0.234 X 0.156	77969	1353
	650-0071-00		1		BUFFER CD ASSY:	80009	650-0071-00
-22	334-3050-00		1		. MKR SET, IDENT:	80009	334-3050-00
-23	380-0384-01		1		. HSG,HALF,RDOUT:LID (ATTACHING PARTS)	80009	380-0384-01
-24	211-0102-00		4		. SCREW,MACHINE:4-40 X 0.500",FLH,STL - - - * - - -	83385	OBD
	175-1948-00		2		. CA ASSY,SP,ELEC:34,28 AWG,30.0 L	80009	175-1948-00
	-----		-		. EACH CABLE ASSY INCLUDES:		
-25	131-0833-00		2		. CONNECTOR,PLUG,:34 CONTACTS	77342	86987-1
-26	175-1084-00		FT		. WIRE,ELECTRICAL:FLAT TYPE,3 INCHES LONG	53387	75037
-27	-----		1		. CKT BOARD ASSY:ROM EXT BUFFER(SEE A2 EPL)		
-28	131-0608-00		68		. TERMINAL,PIN:0.365 L X 0.25 PH,BRZ,GOLD PL	22526	47357
-29	367-0189-00		1		. HANDLE,BOW:2.230 INCH,SST	80009	367-0189-00
-30	380-0343-01		1		. HSG,HALF,RDOUT:BOTTOM	80009	380-0343-01
-31	-----		1		CKT BOARD ASSY:CONTROL(SEE A3 EPL) (ATTACHING PARTS)		
-32	211-0504-00		8		SCREW,MACHINE:6-32 X 0.25 INCH,PNH STL - - - * - - -	83385	OBD
-33	131-0608-00		76		. TERMINAL,PIN:0.365 L X 0.25 PH,BRZ,GOLD PL	22526	47357
-34	351-0500-00		16		. GUIDE,CKT CARD: (ATTACHING PARTS)	80009	351-0500-00
-35	211-0198-00		1		. SCREW,MACHINE:4-40 X 0.438 PNH,STL,POZ - - - * - - -	77250	OBD

Replaceable Mechanical Parts—4051E01

Fig. & Index No.	Tektronix Part No.	Serial/Model No. Eff Dscont	Qty	1 2 3 4 5	Name & Description	Mfr Code	Mfr Part Number
1-36	131-1962-00		8	.	CONN, RCPT, ELEC: CKT CARD, 22/44 CONT	05574	3VH22/1JV3
-37	333-2256-00		1		PANEL, FRONT: (ATTACHING PARTS)	80009	333-2256-00
-38	210-0457-00		4		NUT, PLAIN, EXT W: 6-32 X 0.312 INCH, STL - - - * - - -	83385	OBD
-39	148-0091-00		1		RELAY, ARMATURE: 4 FORM C, 6VDC, 2A, 125VAC	80009	148-0091-00
-40	136-0215-00		1		SKT, PL-IN ELEK: RELAY, 4 POLE, CHASSIS MOUNT (ATTACHING PARTS)	77342	27E126
-41	211-0008-00		1		SCREW, MACHINE: 4-40 X 0.25 INCH, PNH STL	83385	OBD
-42	210-0586-00		1		NUT, PLAIN, EXT W: 4-40 X 0.25 INCH, STL - - - * - - -	78189	211-041800-00
-43	120-1098-00		1		XFMR, PWR, STPDN: (ATTACHING PARTS)	80009	120-1098-00
-44	212-0516-00		4		SCREW, MACHINE: 10-32 X 2 INCH, HEX HD STL	77250	OBD
-45	210-0812-00		4		WASHER, NONMETAL: #10, FIBER - - - * - - -	86445	OBD
-46	166-0227-00		4		INS SLV, ELEC: 0.187 ID X 1.50 INCH LONG	80009	166-0227-00
-47	407-1906-00		1		BRACKET, RELAY: ALUMINUM	80009	407-1906-00
-48	384-0632-00		4		POST, ELEC-MECH: 0.375 X 1.109" LONG, 10-32 (ATTACHING PARTS FOR EACH)	80009	384-0632-00
-49	212-0507-00		1		SCREW, MACHINE: 10-32 X 0.375 INCH, PNH STL - - - * - - -	83385	OBD
-50	252-0571-00		FT		NEOPRENE EXTR: CHAN, 0.234 X 0.156	77969	1353
-51	386-3665-00		1		SUPPORT, CAP.: (ATTACHING PARTS)	80009	386-3665-00
-52	211-0510-00		1		SCREW, MACHINE: 6-32 X 0.375 INCH, PNH STL	83385	OBD
-53	210-0202-00		1		TERMINAL, LUG: 0.146 ID, LOCKING, BRZ TINNED - - - * - - -	78189	2104-06-00-2520N
-54	-----		2		MICROCIRCUIT, LI: (SEE Q1 AND Q11 EPL)		
	-----		1		MICROCIRCUIT, LI: (SEE Q21 EPL) (ATTACHING PARTS FOR EACH)		
-55	211-0008-00		1		SCREW, MACHINE: 4-40 X 0.25 INCH, PNH STL - - - * - - -	83385	OBD
-56	-----		1		MICROCIRCUIT, LI: (SEE Q31 EPL) (ATTACHING PARTS)		
-57	211-0008-00		1		SCREW, MACHINE: 4-40 X 0.25 INCH, PNH STL	83385	OBD
-58	210-1171-00		1		WSHR, SHOULDERED: 0.116 ID X 0.138 INCH OD - - - * - - -	52905	A7148516P2
-59	342-0163-00		1		INSULATOR, PLATE: XSTR, 0.675 X 0.625 X 0.001"	80009	342-0163-00
-60	-----		1		CKT BOARD ASSY: POWER SUPPLY (SEE A1 EPL) (ATTACHING PARTS)		
-61	211-0504-00		4		SCREW, MACHINE: 6-32 X 0.25 INCH, PNH STL - - - * - - -	83385	OBD
-62	131-0608-00		6		TERMINAL, PIN: 0.365 L X 0.25 PH, BRZ, GOLD PL	22526	47357
-63	129-0209-00		4		SPACER, POST: 0.375 L, W/6-32 THD THRU, BRS	80009	129-0209-00
-64	432-0048-01		3		BASE, CAP. MTG: (ATTACHING PARTS FOR EACH)	80009	432-0048-01
-65	211-0588-00		2		SCREW, MACHINE: 6-32 X 0.75 INCH, HEX. HD STL	83385	OBD
-66	210-0407-00		2		NUT, PLAIN, HEX.: 6-32 X 0.25 INCH, BRS - - - * - - -	73743	3038-0228-402
	290-0508-00		1		CAP., FXD, ELCTLT: 18,000UF, +100-10%, 15V	56289	68D10444
	290-0753-00		2		CAP., FXD, ELCTLT: 4500UF, +75-10%, 30V	90201	20-30431
-67	386-0254-00		6		RETAINER, CAP.: LARGE FIBER	98627	OBD
-68	380-0410-00		1		RTNR, AIR FILTER: ABS (ATTACHING PARTS)	80009	380-0410-00
-69	211-0504-00		4		SCREW, MACHINE: 6-32 X 0.25 INCH, PNH STL - - - * - - -	83385	OBD
-70	378-0053-00		1		FIL ELEM, AIR CO: AIR	80009	378-0053-00
-71	119-0492-00		1		FAN, AXIAL: MUFFIN TYPE, 3 INCH DIA, 115V (ATTACHING PARTS)	82877	SU2C5
-72	211-0552-00		4		SCREW, MACHINE: 6-32 X 2 INCH, PNH STL	83385	OBD
	210-0803-00		4		WASHER, FLAT: 0.15 ID X 0.032 THK, STL CD PL	12327	OBD
-73	385-0080-00		4		SPACER, POST: 0.437 L W/6-32 THD THRU, AL - - - * - - -	80009	385-0080-00

Replaceable Mechanical Parts—4051E01

Fig. & Index No.	Tektronix Part No.	Serial/Model No. Eff Dscont	Qty	1	2	3	4	5	Name & Description	Mfr Code	Mfr Part Number
1-	378-0865-00		1						FLTR,SCRN MESH:3.2 SQUARE,ALUMINUM	80009	378-0865-00
	378-0866-00		1						SCREEN,FAN:3.2 X 1.625 L,ALUMINUM	80009	378-0866-00
-74	119-0813-00		1						SELECTOR,VOLTS:W/LINE FLTR RCPT & FUSE	02777	F65003
-75	333-2255-00		1						PANEL,REAR:	80009	333-2255-00
									(ATTACHING PARTS)		
-76	211-0504-00		4						SCREW,MACHINE:6-32 X 0.25 INCH,PNH STL	83385	OBD
									- - - * - - -		
-77	210-0202-00		1						TERMINAL,LUG:0.146 ID,LOCKING,BRZ TINNED	78189	2104-06-00-2520N
									(ATTACHING PARTS)		
-78	210-0408-00		2						NUT,PLAIN,HEX.:6-32 X 0.312 INCH,BRS	73743	3040-402
									- - - * - - -		
-79	343-0213-00		3						CLAMP,LOOP:PRESS MT,PLASTIC	80009	343-0213-00
	98-3453-00		1						WIRE SET,ELEC:	80009	198-3453-00
	-----		1						. CABLE ASSY:J2/J40		
-80	175-0829-00		FT						. . WIRE,ELECTRICAL:6 WIRE RIBBON	08261	SS-0626-710610C
-81	131-0707-00		12						. . CONNECTOR,TERM.:22-26 AWG,BRS& CU BE GOLD	22526	47439
-82	352-0164-02		1						. . CONN BODY,PL,EL:6 WIRE RED	80009	352-0164-02
	352-0164-00		1						. . CONN BODY,PL,EL:6 WIRE BLACK	80009	352-0164-00
	-----		1						. CABLE ASSY:		
-83	175-0825-00		FT						. . WIRE,ELECTRICAL:2 WIRE RIBBON	80009	175-0825-00
-84	131-0707-00		2						. . CONNECTOR,TERM.:22-26 AWG,BRS& CU BE GOLD	22526	47439
-85	352-0169-09		1						. . CONN BODY,PL,EL:2 WIRE WHITE	80009	352-0169-09
-86	131-0861-00		2						. TERM, QIK DISC:16-20 AWG,0.22 W X 0.02 THK	00779	42617-2
	131-1041-00		2						. CONTACT,ELEC:QUICK DISCONNECT	00779	61060-2
-87	131-1997-00		4						. CONNECTOR,TERM.:22-26 AWG,TINPLATED	22526	75295-005
-88	441-1357-00		1						CHAS,EXPANDER:MAIN	80009	441-1357-00
									(ATTACHING PARTS)		
-89	211-0507-00		6						SCREW,MACHINE:6-32 X 0.312 INCH,PNH STL	83385	OBD
									- - - * - - -		
-90	348-0419-00		4						FOOT,CABINET:FRONT	80009	348-0419-00
									(ATTACHING PARTS FOR EACH)		
-91	211-0504-00		2						SCREW,MACHINE:6-32 X 0.25 INCH,PNH STL	83385	OBD
									- - - * - - -		
-92	390-0556-00		1						CABINET BOTTOM:	80009	390-0556-00

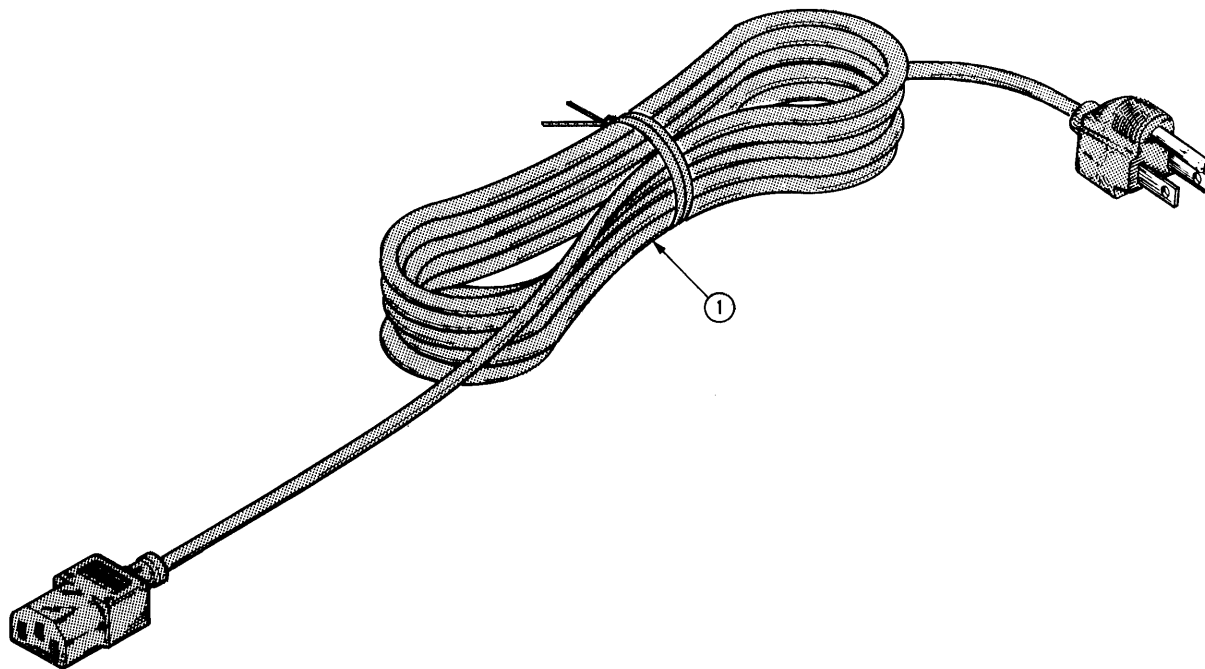

Fig. & Index No.	Tektronix Part No.	Serial/Model No.		Qty	1	2	3	4	5	Name & Description	Mfr Code	Mfr Part Number
		Eff	Dscont									
STANDARD ACCESSORIES												
-1	161-0066-00 070-2215-00			1						CABLE ASSY,PWR:3 WIRE,98 INCH LONG	80009	161-0066-00
				1						MANUAL,TECH:INSTRUCTION	80009	070-2215-00

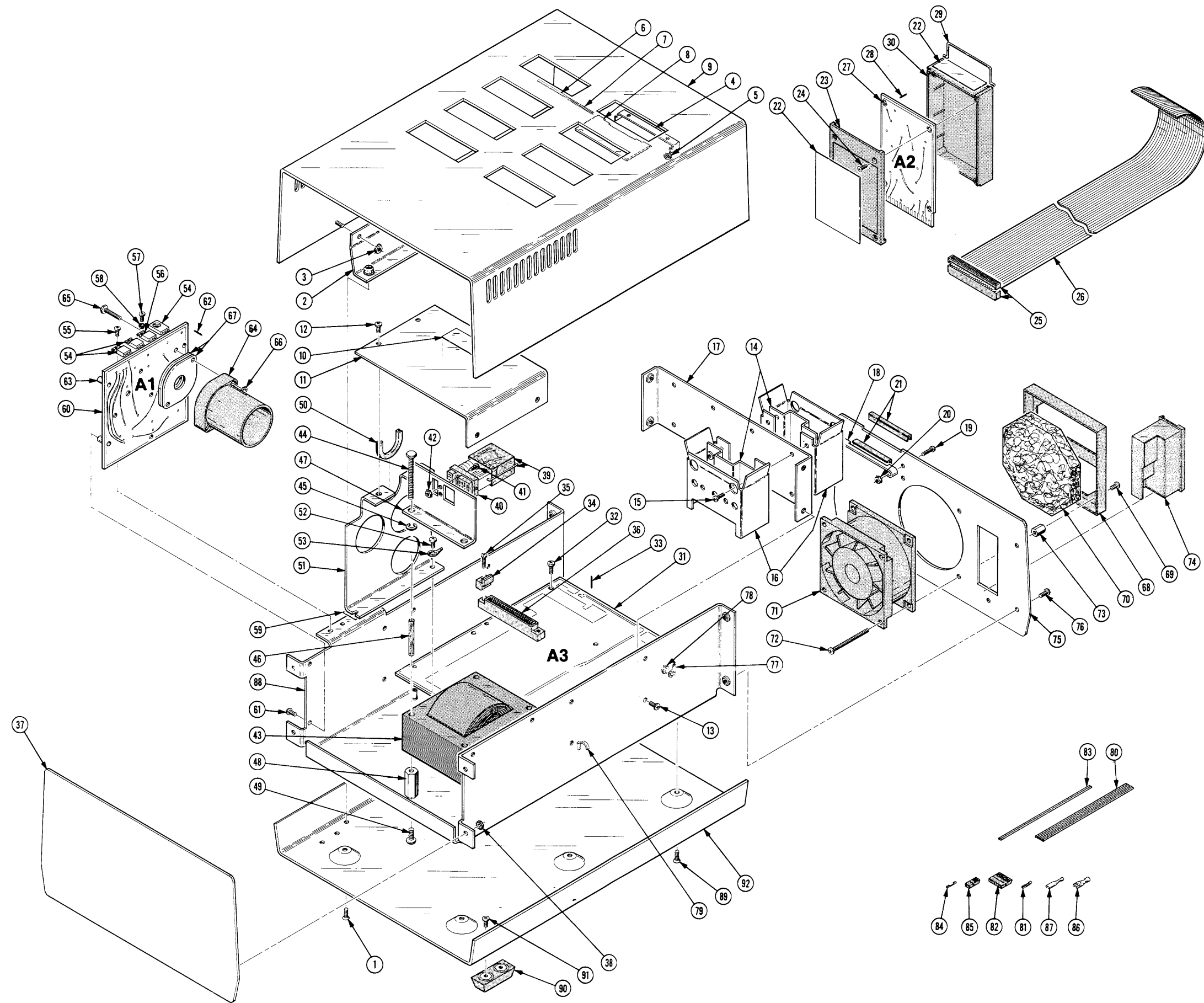

FIG 1 EXPLODED VIEW